

PHONICS

L E T T E R

of the

Week



Lavinia Pop

Thank you for downloading this product; I hope you will enjoy using it and that it will be a valuable resource for you! I value your feedback, so please don't hesitate to contact me if you have any concerns whatsoever as I will endeavour to address them. And if you like what I've done, please let me know by leaving feedback at my online store :)

Lavinia

lavinia@inmyworld.com.au

ILLUSTRATIONS Just So Scrappy 2, Pink Cat Studio, TeacherScrapbook, Little Red, Jessica Weible Illustrations, Dancing Crayon Designs, Blue Bees Workshop, Ramona Majdis, Kari Bolt, Whimsy Clips

www.justsoscrappytoo.com www.pinkcatstudio.com www.teacherspayteachers.com/Store/Teacherscrapbook
www.teacherspayteachers.com/Store/Littlered www.shop.jwillustrations.com www.dancingcrayon.com
www.teacherspayteachers.com/Store/Blue-Bees-Workshp www.teacherspayteachers.com/Store/Ramona-Majdis
www.teacherspayteachers.com/Store/Kari-Bolt www.teacherspayteachers.com/Store/Whimsy-Clips

FONTS www.schoolfonts.com.au www.teacherspayteachers.com/Store/Kimberly-Geswein-Fonts

PRINTING TIP This resource has been designed for printing on A4-sized paper. If you are printing on a different size, select “shrink to printable area” or “print to fit page” (or a similar option) in order for the contents of this unit to print correctly.

Copyright © 2013–2016 by Lavinia Pop – All rights reserved by author.

Purchase of this item entitles the purchaser the right to reproduce the pages for personal and classroom use. Duplication for other classes, an entire school or commercial purposes is strictly prohibited without written permission from the author. Minor editing is permitted only for personal use, however the document remains under copyright even when edited. Posting this item in whole or in part on the Internet in any form is strictly prohibited and is a violation of the Digital Millennium Copyright Act (DMCA). Please be fair and don't share! If you are not the original purchaser of this file, please visit my blog to obtain a link to one of my online stores. www.inmyworld.com.au

Click to connect...



www.inmyworld.com.au



www.facebook.com/inmyworldlaviniapop



www.pinterest.com/laviniapop

Contents

Introduction	4-8
Poster with correct letter formation	9
Poster with CVC words	10
Flash cards with correct letter formation	11
Play dough mat with correct letter formation	12
Write and wipe cards with correct letter formation	13
Write and wipe letter mat	14
Vocabulary cards	15-18
Doggie, Where's the Sound? game	19-24
Build-a-sentence center	25-26
Letter flip book	27-30
Activity mini-book	31
Alphabet reader	32-43
Missing letter cut and paste reader	44-51
Picture scramble cut and paste booklet	52-59
Letter maze	60
Font discrimination maze	61
Hidden letter worksheet (2 sets)	62-63
Beginning sounds colouring worksheet	64
Letter find	65
Handwriting practice	66-67
Upper and lower case cut and paste	68-69
Beginning sounds cut and paste	70-71
CVC words cut and paste	72-73
CVC word match	74
Letter identification worksheet	75
Build-a-sentence cut and paste worksheet (set of 5)	76-80
Homework reading sheet	81
Alphabet crown	82-84
Letter craft	85-86

Introduction

About this book:

This Phonics Letter of the Week unit has been designed to be used with children in Kindergarten (Prep). It contains a variety of games, activities and worksheets that will help teach correct letter formation, letter identification and recognition of letter sound.

The purpose of creating the Phonics Letter of the Week series, to which this unit belongs, was to provide a means by which one letter of the alphabet could be taught at a time. A great emphasis is placed on letter sounds, which makes this an ideal tool for teaching phonics.

Directions for use:

Before you begin...

Have the children say out loud the sound of the letter each time they work on a tracing worksheet; this will reinforce the relationship between the letter and the sound it makes. In addition to this, children will remember the sounds as they begin to read later on, and those that have trouble with reversals (such as the letters "b" and "d"), will remember that "b" starts at the top and "d" starts at the circle.

Following is an outline of what you will find in this book and suggestions for implementing the content in your classroom or home.

1. Poster with correct letter formation

To prepare the poster for use, print, laminate and display on your wall.

2. Poster with CVC words

This poster displays 10 CVC words that either begin with or contain the letter in focus. To set up, print laminate and display on your wall or include it in a file-folder word wall. (Please note: some vowel units do not contain CVC words or display 10 words).

3. Flash cards with correct letter formation

These cards display correct letter formation for both upper and lower case letters. They can be used as flash cards, tracing cards or even displayed as posters. To prepare the cards for use, print them out, laminate for durability and then cut them apart (optional).

4. Play dough mat with correct letter formation

Children will have lots of fun using play dough to reproduce the letters on the mat! They will learn correct letter formation and build up their fine motor skills in preparation for writing. To set up, print and laminate. (Cut in half if you want separate cards).

5. Write and wipe cards with correct letter formation

Children can practice correct letter formation over and over with these cards using a dry-erase (whiteboard) marker. To prepare the cards for use, print, laminate and cut out. To keep the cards together, make a hole in the top left hand corner and secure with a key ring or pipe cleaner.

6. Write and wipe letter mat

This mat has been designed for use in a Write and Wipe center with a dry-erase (whiteboard) marker. Children trace both upper and lower case letters, a word that begins with the focus letter and 5 CVC words that begin with or contain the focus letter. To prepare, print and laminate.

7. Vocabulary cards

This set contains 18 vocabulary cards that begin with the focus letter and 9 cards that contain or end with focus letter. These can be used as:

- vocabulary flash cards
- a matching card game (for which you will need to print 2 sets)

To prepare for use, print, laminate and cut the cards apart.

I have also included a Write the Room activity worksheet. Children write down as many words that begin with the focus letter that they can see in the room.

8. Sound Hound center activity

Set-Up: Print, laminate and cut out the dog you prefer to use and the picture cards. Cut the dog down the dotted lines to separate the head, middle and tail sections.

Each card displays a picture with the focus letter above it. The aim is for children to identify the position of the letter (beginning/head; middle/tummy or end/tail) as they say each word, and place the cards under the corresponding dog section. They then complete the accompanying worksheet. (The worksheet can also be used independently of the center activity).

9. Build-a-sentence

Set-Up: Print the contents of this page and laminate it for durability. Cut out the sentence base (entire first row) and along the dotted lines of the picture cards to obtain 8 squares. You may store these in a large zip-lock bag.

The aim of this game is to practice reading a predictable sentence using different vocabulary words that begin with the focus letter. Children choose a picture card from the pile and place it over the coloured square on the sentence frame, then read the sentence out loud. I have included a recording sheet children to complete once they finish the activity.

10. Alphabet flip book

Set-Up: Assembly is required, either by teacher or students. You will need to cut around each rectangle box, then along the dashed lines of the bottom one. Make sure that the top rectangle is left intact as it will form the base for the flip book! Arrange the word cards one on top of the other and staple them to the base. Students will have lots of fun reading their books over and over again to friends and family! I have included a couple of recording sheets for this activity.

11. Activity mini book

A foldable mini-book with different activities: letter identification, beginning sounds and letter tracing. Simply fold the page vertically, down the middle, and then horizontally to create the book.

12. Alphabet reader

Set-Up: I have included 2 versions of this activity: black and white and coloured. Once you have selected your preferred version, print, then either teacher or student will need to cut each page in half and staple on the left hand margin to form a book. Children practice reading a predictable sentence that uses the most common sight words and simple words (mostly CVC) that begin with the focus letter.

13. Missing letter cut and paste reader

Set-Up: Once printed, place each page on top of each other in order, cut in half and staple to make 2 booklets. Also cut the last page so that you will get 3 strips of 6 letter pairs. Children are required to cut the 6 pairs apart and paste one on each page of their booklet, and then read the sentence on the page.

14. Picture scramble cut and paste booklet

Set-Up: Print the pages, stack them on top of each other and cut in half to form 2 booklets. Staple each one. Print the end scrambled picture tiles and leave it as is – children will cut these tiles apart and used them to build the words inside their booklets. Once all the words have been built, the right hand column on each page may be completed by colouring the word, tracing it, then writing it.

15. Letter maze

Children complete this worksheet by colouring the squares that contain the focus upper and lower case letters. The aim is to make a pathway from one end of the maze to the other.

16. Font discrimination maze

Children complete this worksheet by colouring the circles that contain the letter in focus. The aim is to help children recognise the focus letter written in different fonts.

17. Hidden letter worksheet (2 pages)

Children reveal the hidden letter by colouring each section using the colours indicated at the top of the page.

18. Beginning sounds colouring worksheet

Children colour the pictures that begin with the focus sound.

19. Letter Find

Children search for both upper and lower case letters, then write the number of times each one was found in the circles on the left hand side.

20. Handwriting practice (dotted and continuous line version included)

Children practice writing both upper and lower case letters.

21. Upper and lower letter sort (dotted and continuous line version included)

The main focus of this worksheet is on lower and upper case letter identification. Children trace the letters then cut out the letter from the bottom of the page and paste them in the correct column to show which ones are upper case and those that are lower case.

22. Beginning sounds cut and paste (dotted and continuous line version included)

Children begin this worksheet by tracing the upper and lower case letters at the top of the page and then cut out the pictures from the bottom of the page and paste them in the correct column to show whether they begin or don't begin with the focus sound.

23. Word match cut and paste (dotted and continuous line version included)

Children read the words in the left hand column and then trace them. To demonstrate comprehension, they are asked to cut the pictures from the bottom of the page and paste them next to the matching word. Finally, they write the words in the right hand column.

24. CVC read-match-write

Children read the words in the left column and then draw a line to match them to the correct pictures in the middle. Next, children write the words in the boxes on the right side of the page and then draw lines to match them to the pictures too.

25. Homework reading page

This homework sheet focuses on letter sounds. Children are asked to say the names for each of the pictures on the page and identify the position of the sound. Next, they think of other words that contain the focus sound and then they read a 5 CVC words.

26. Alphabet reading strips with CVC words (excluding vowel letters)

Children read the sentences on the page using the predictable pattern: "... is for..." Picture cues are given for each vocabulary word.

27. Reading page

Children trace the words at the top of the page and then underline the focus lower case letter in each one. Next, they underline or highlight the upper and lower case letters in the nursery rhyme at the bottom of the page and then then write how many focus letters were found.

28. Build-a-sentence cut and paste worksheets (set of 5)

Children begin this worksheet by reading a simple sentence, cutting and pasting the words from the bottom of the page in correct order to form the sentence, writing the sentence and then colouring a picture. (Please note: this set contains the same wording as in the reader.)

29. Alphabet crown

The crown can be completed at the end of the week as an “I know the letter!” achievement activity. Children cut out their crowns on the cutting line or around the solid shape. They also cut out the shapes containing 3 pictures and glue them onto their crowns. I have also included letter tracing head wraps that can be secured to each side of the crown to form the back part of it. Usage of this is optional; students could use string instead to tie to the crown so it will sit on their heads.

30. Alphabet craft

These two pages contain blank upper and lower case letter templates that you can use with children to create letter activities and crafts. Please visit my blog for craft ideas:
www.inmyworld.com.au/category/preschool

Happy Teaching :)

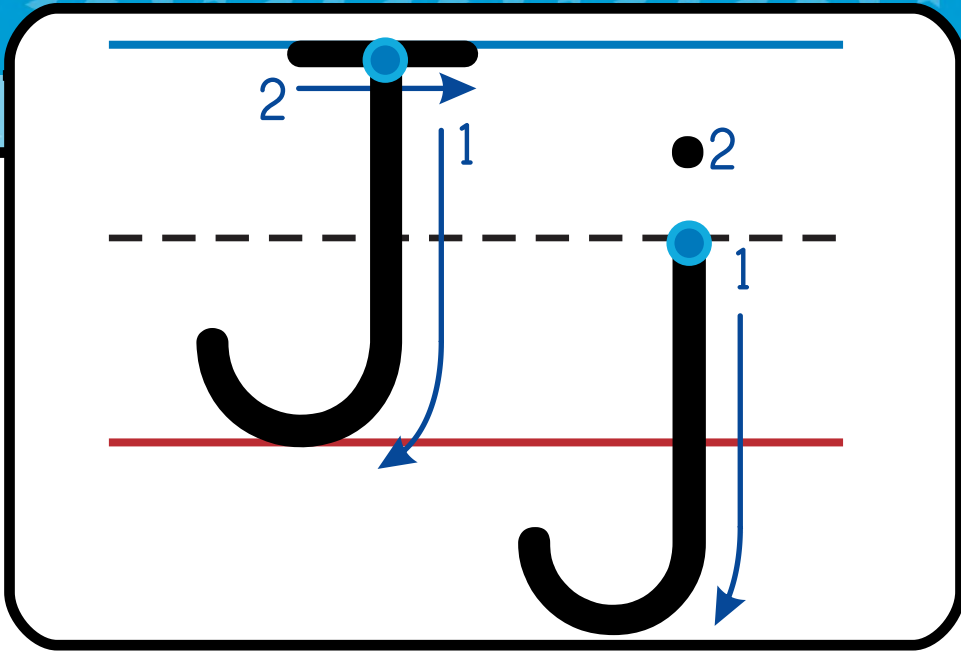

jam

Jj

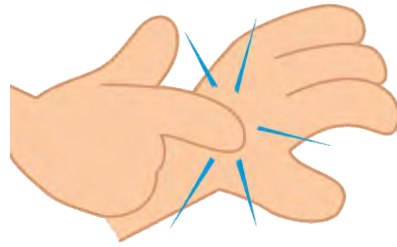

The dog



jab

jag

jam

jet

jig

Jim

job

jog

jot

jug

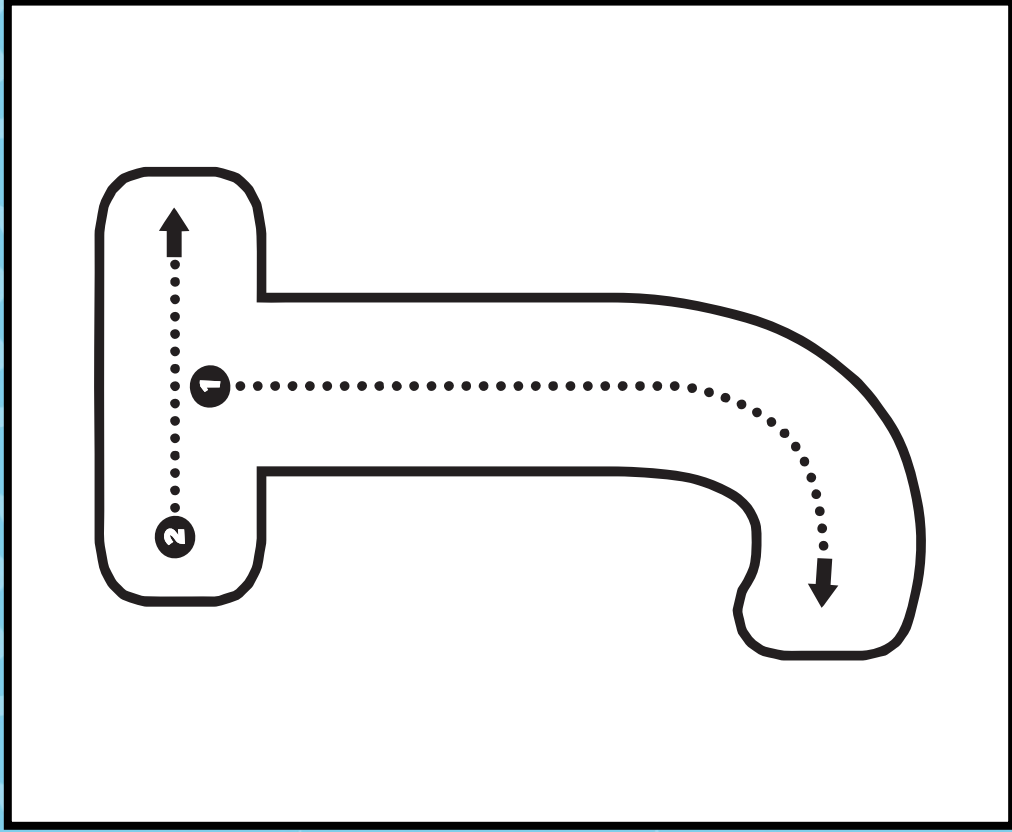

Lavinia Pop © 2013



Jill

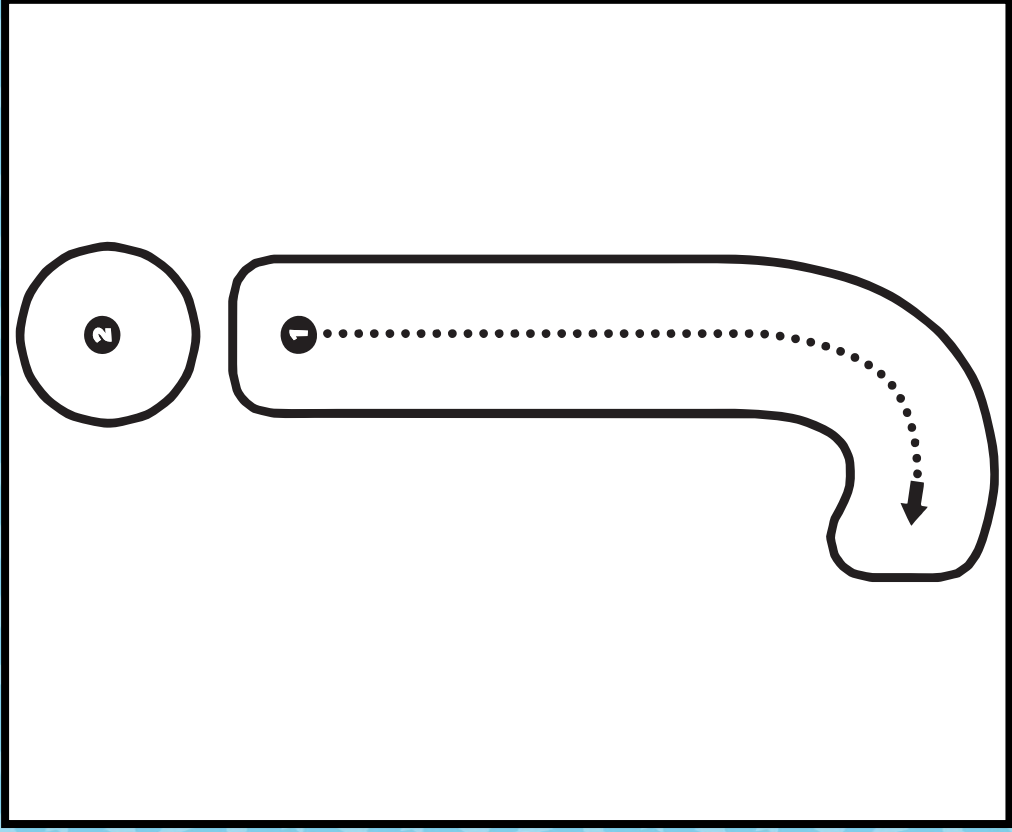

Lavinia Pop © 2013



jam

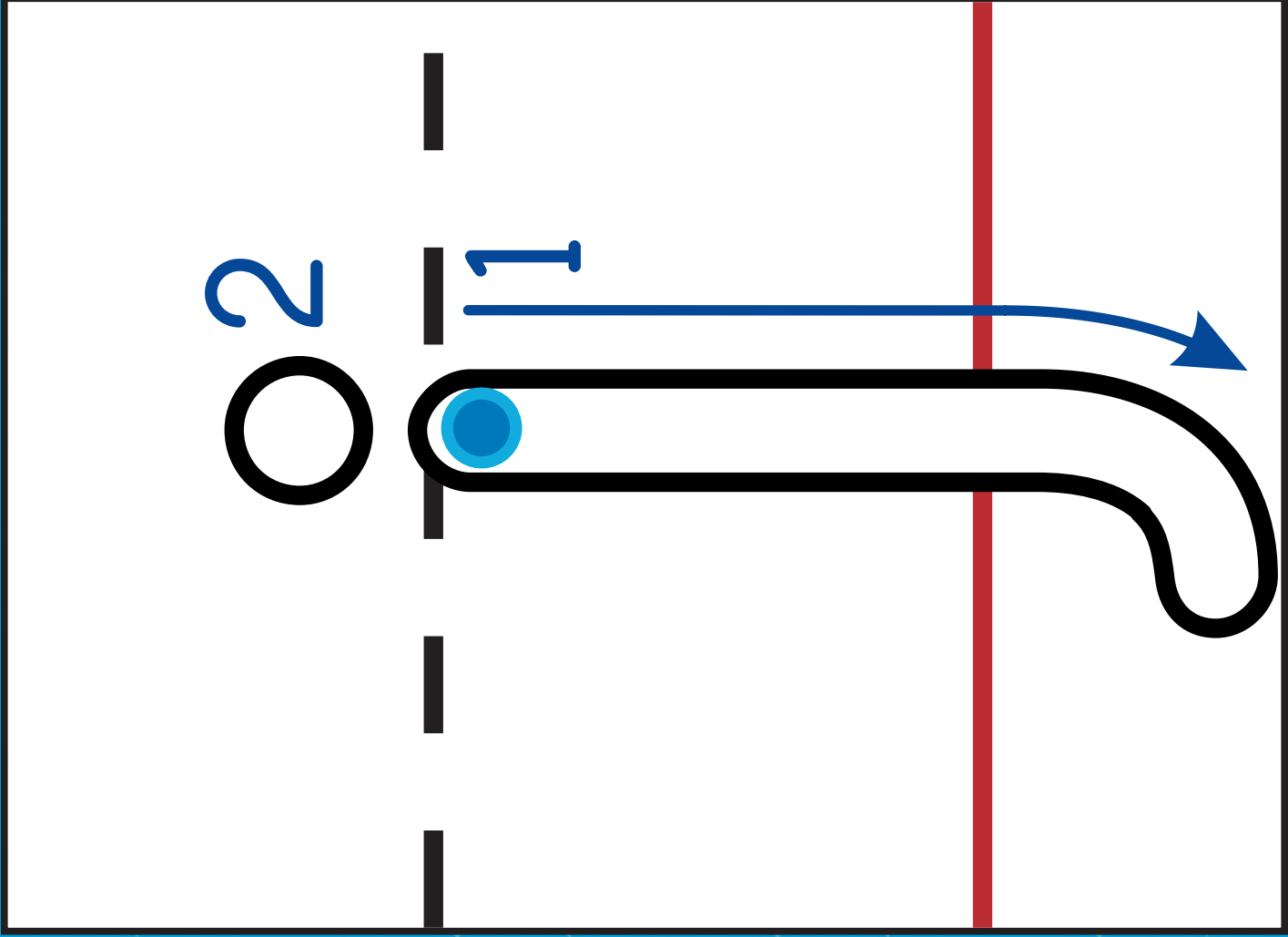
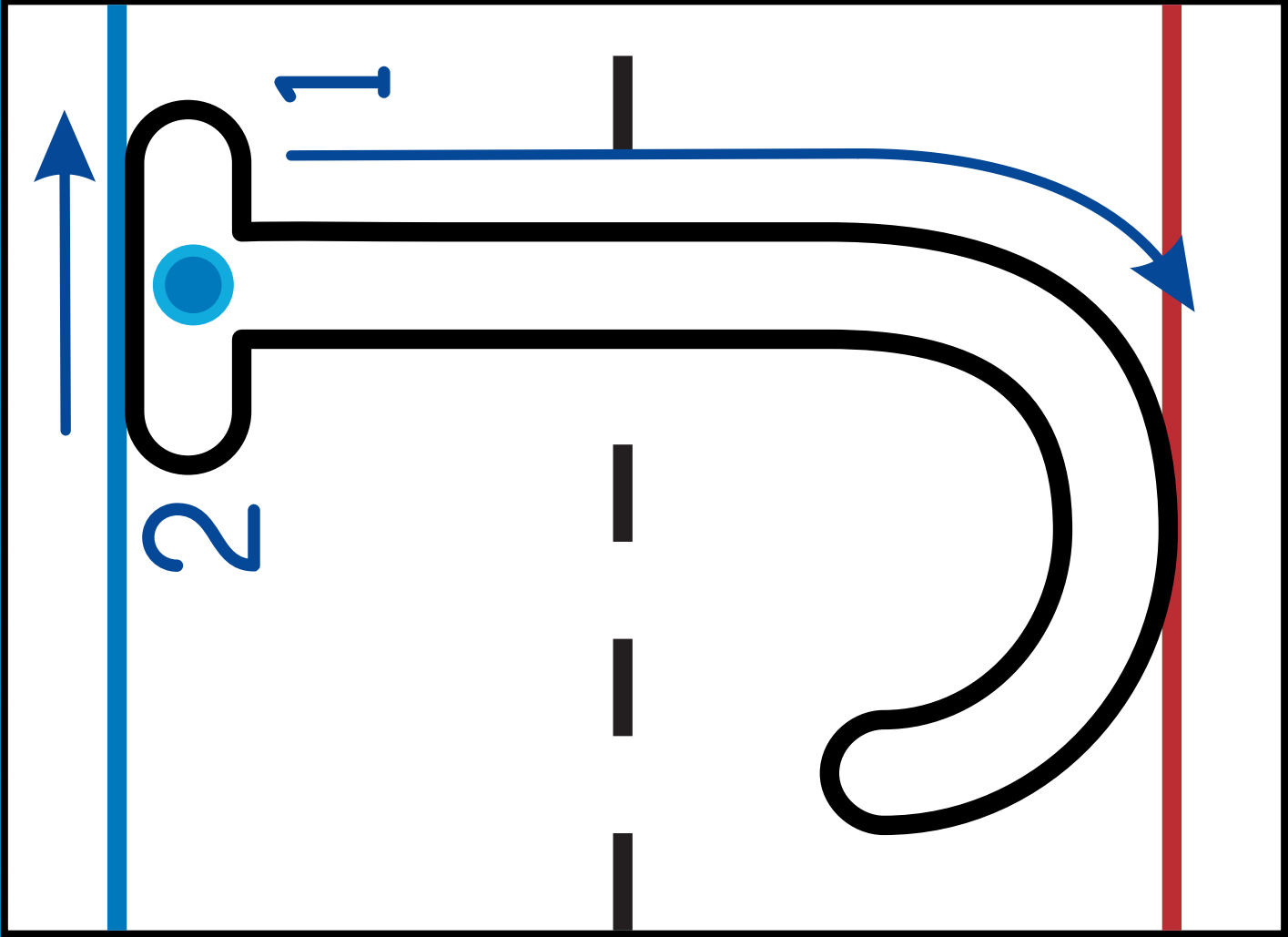

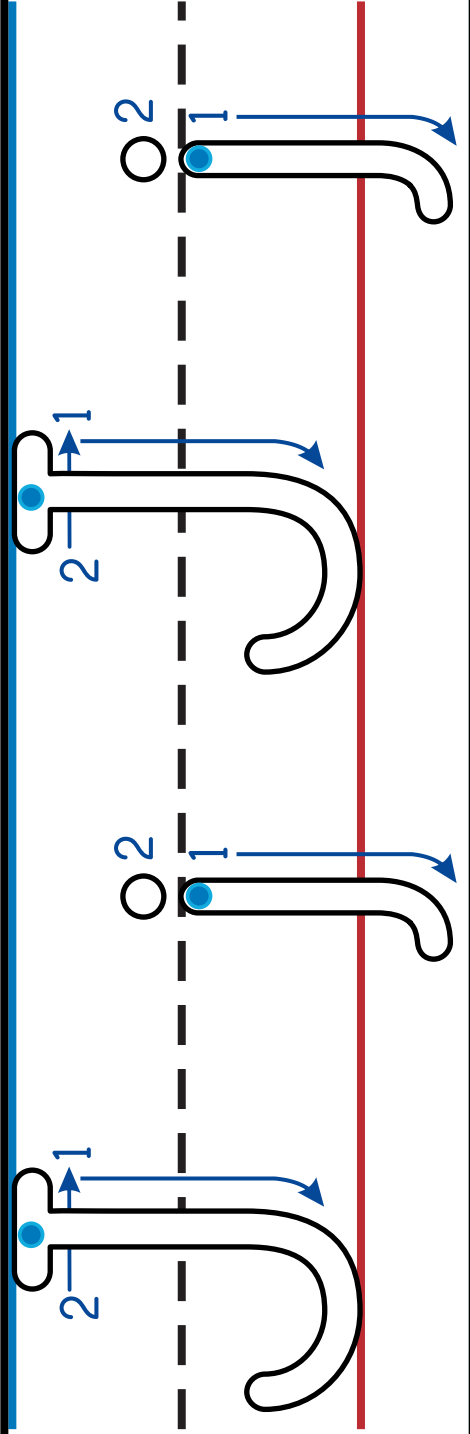
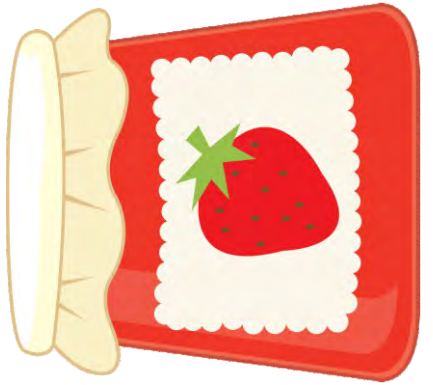
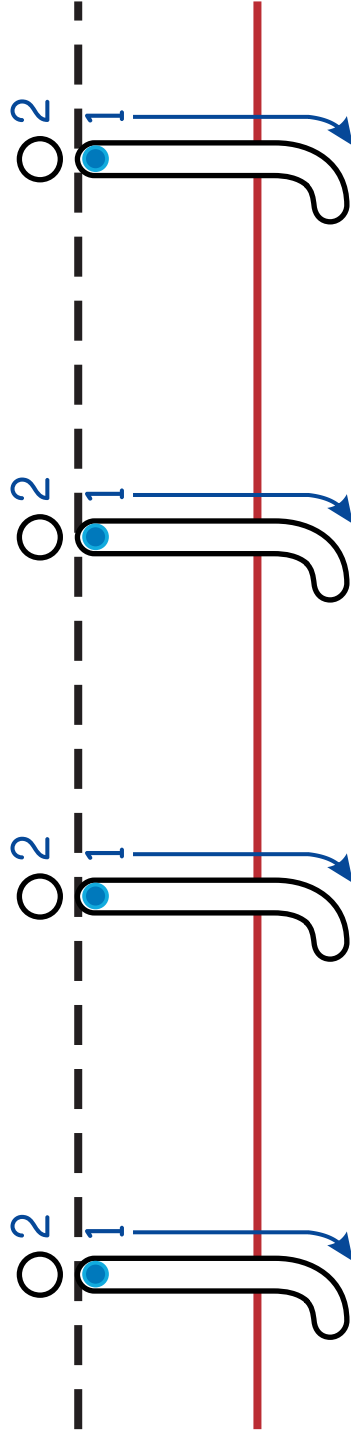
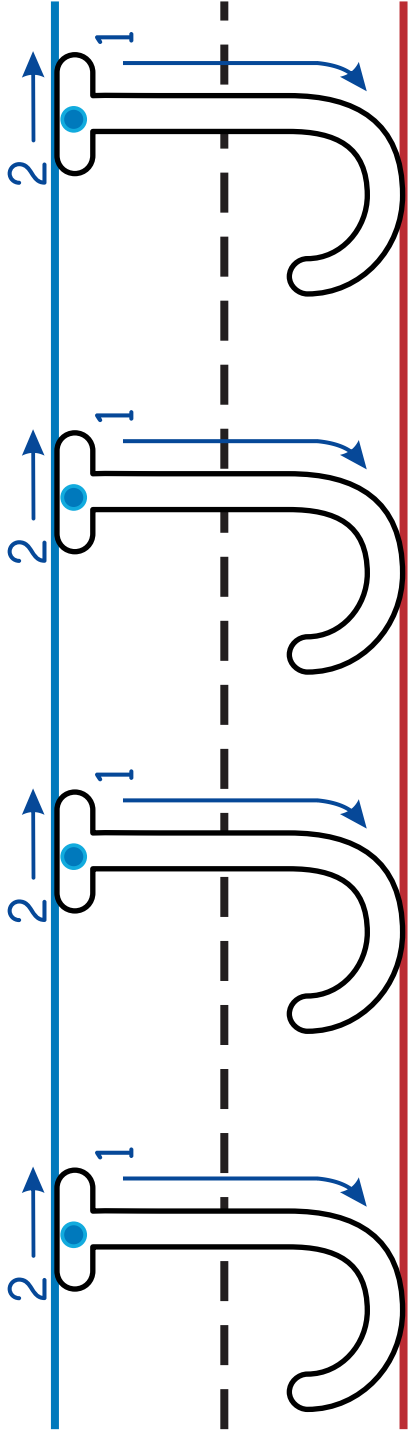

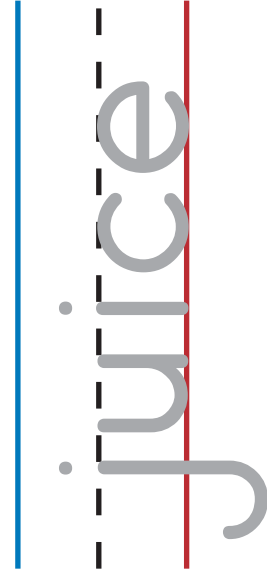
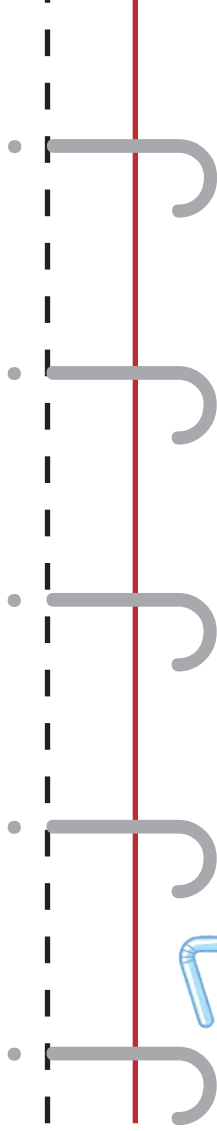
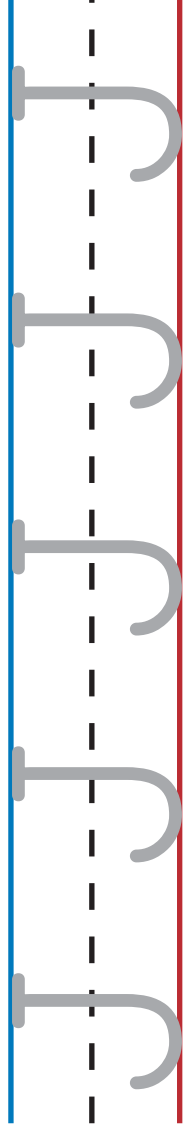
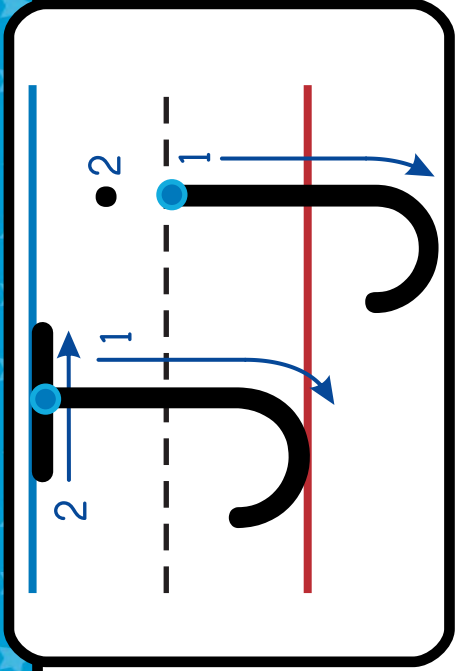

jam



jet

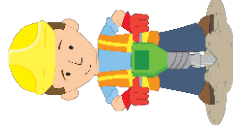

jig



job



jug

jab

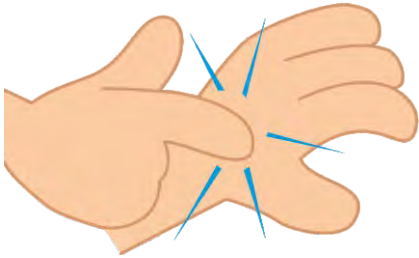

jam



jet

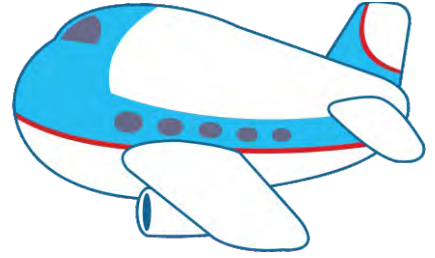

jig



job



jot



jog



jug



jump



juice



jewel



jellyfish



juggle



jeans



jacket



jellybeans



jar



Jesus



pajamas



banjo

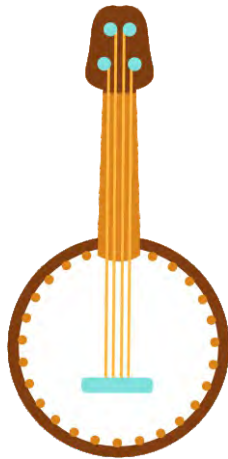

ninja



injury



majesty



project



enjoy



subject

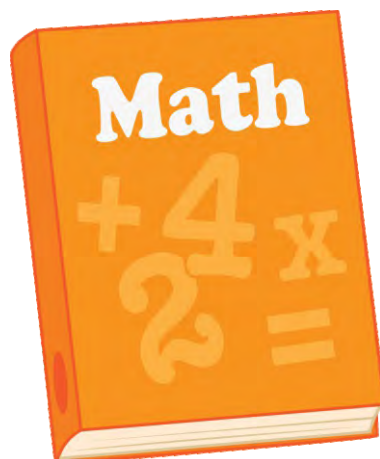

Please Note: As there are no English words that end with the j sound, I have not included any ending sound picture cards.

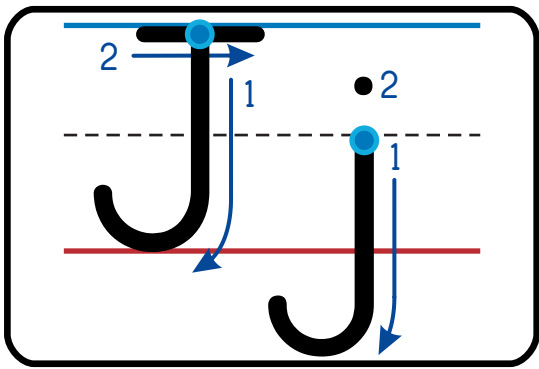

Name:

Write the Room

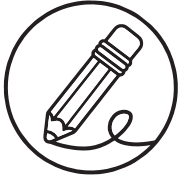

These are the words I found:

1 _____

6 _____

2 _____

7 _____

3 _____

8 _____

4 _____

9 _____

5 _____

10 _____

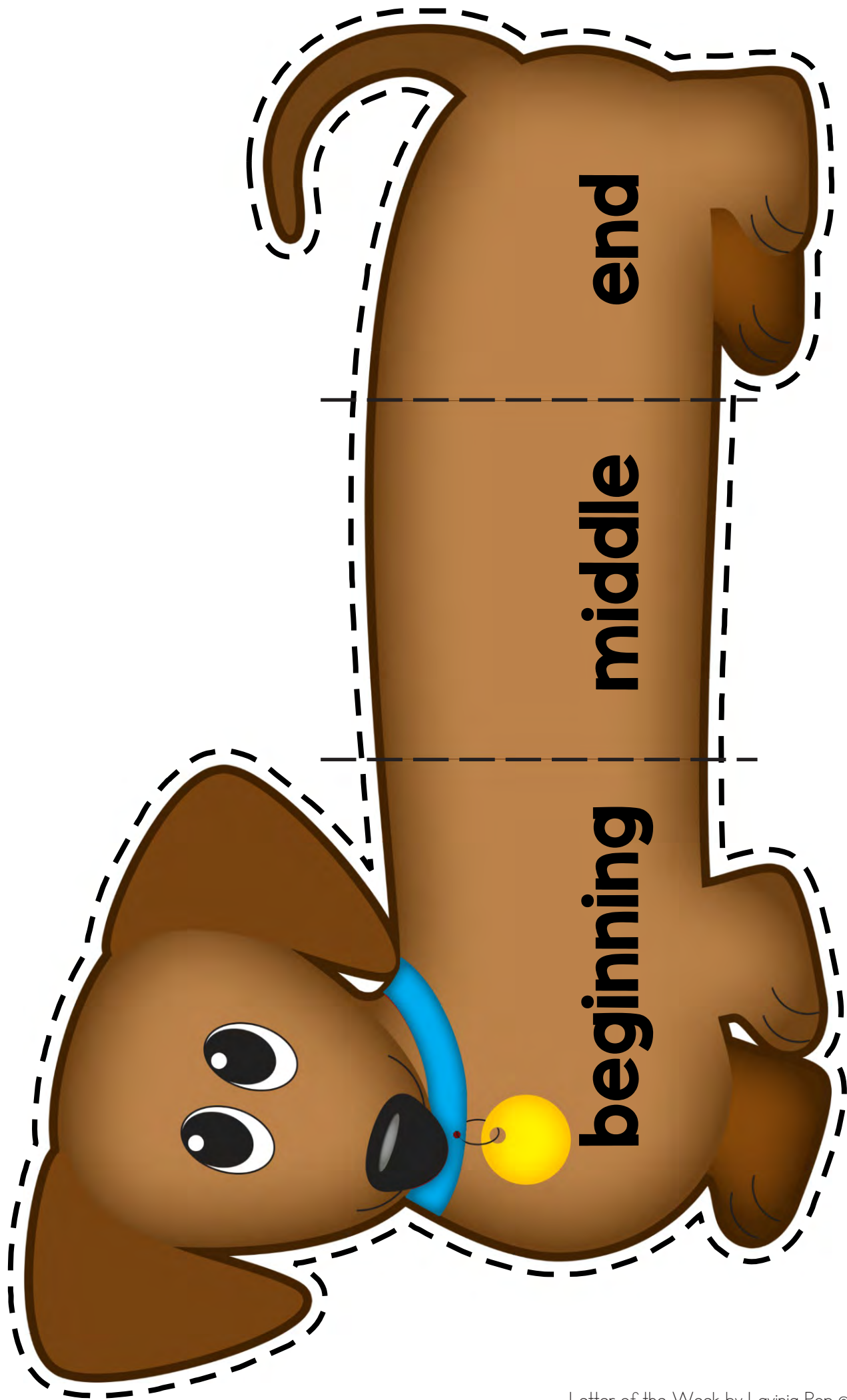

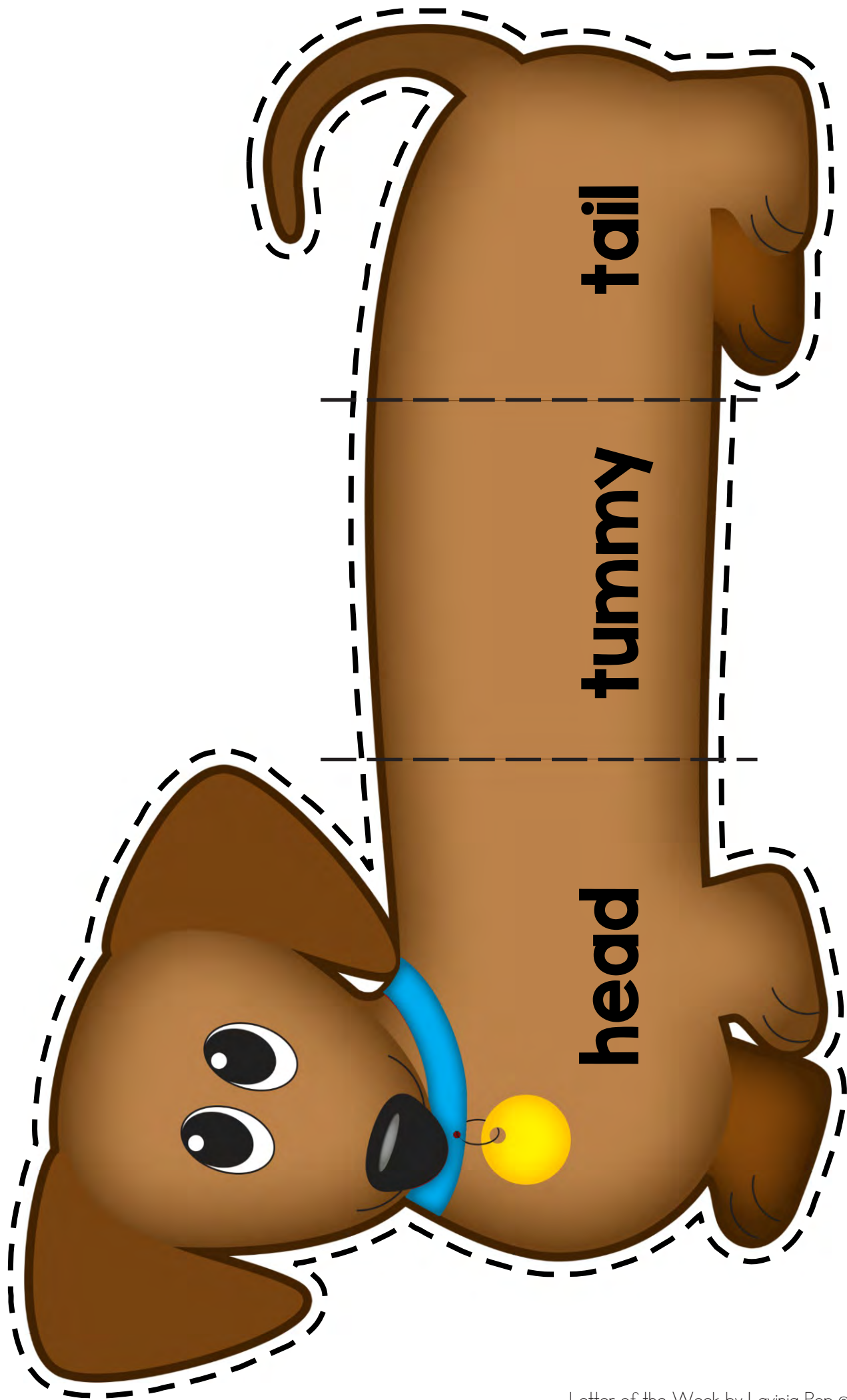

j



j



j

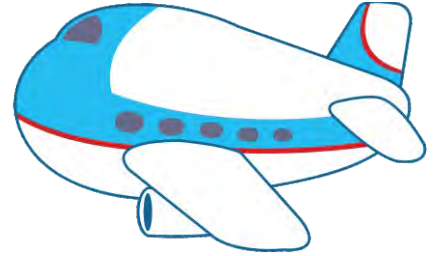

j



j



j



j



j



j



j



j

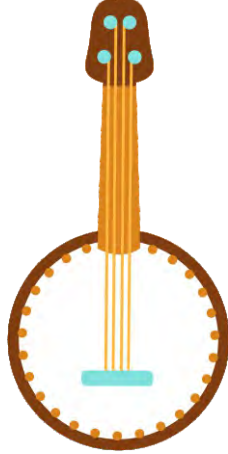

j



j



j



j



j



j

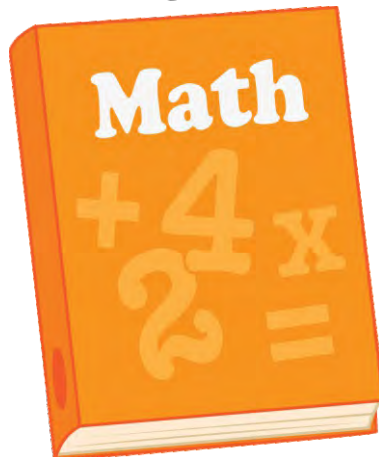

j



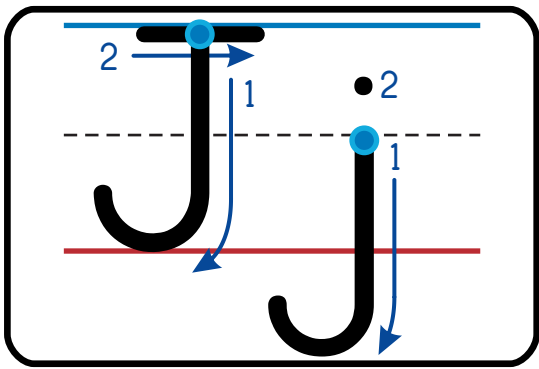

Name:

Sound Hound



Cut and paste the pictures in the columns below to show where you heard the sound.

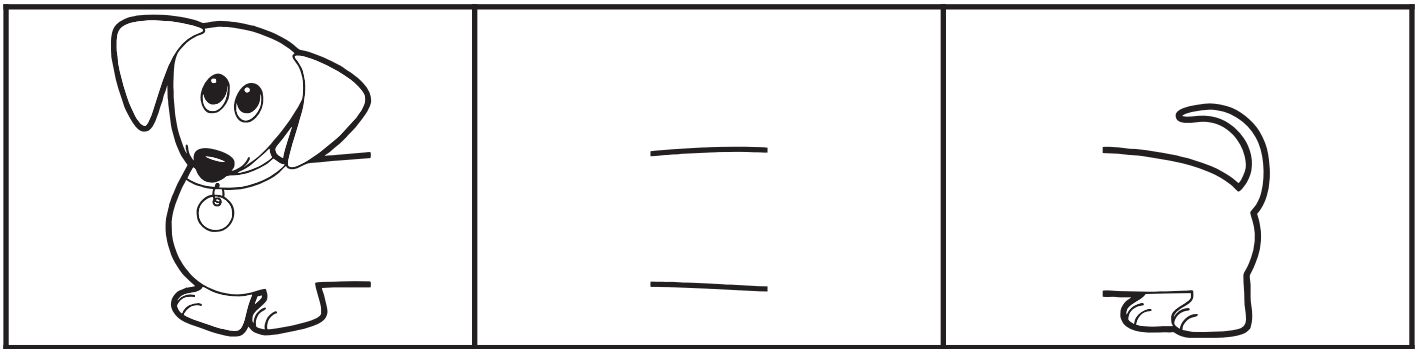

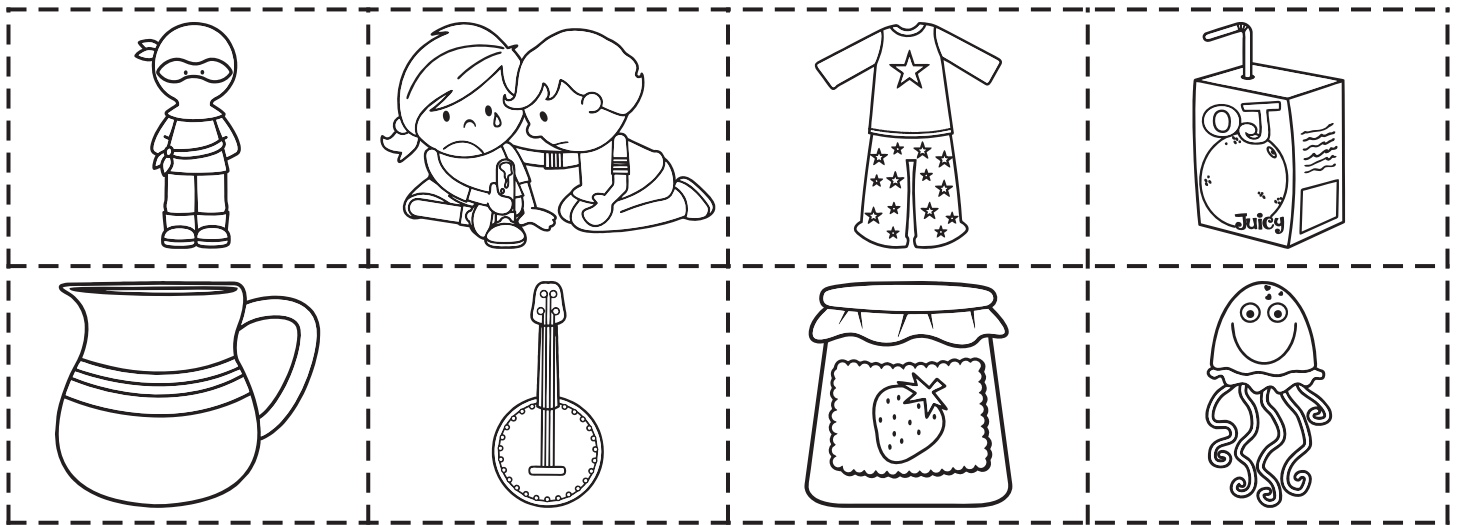
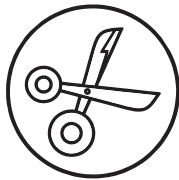
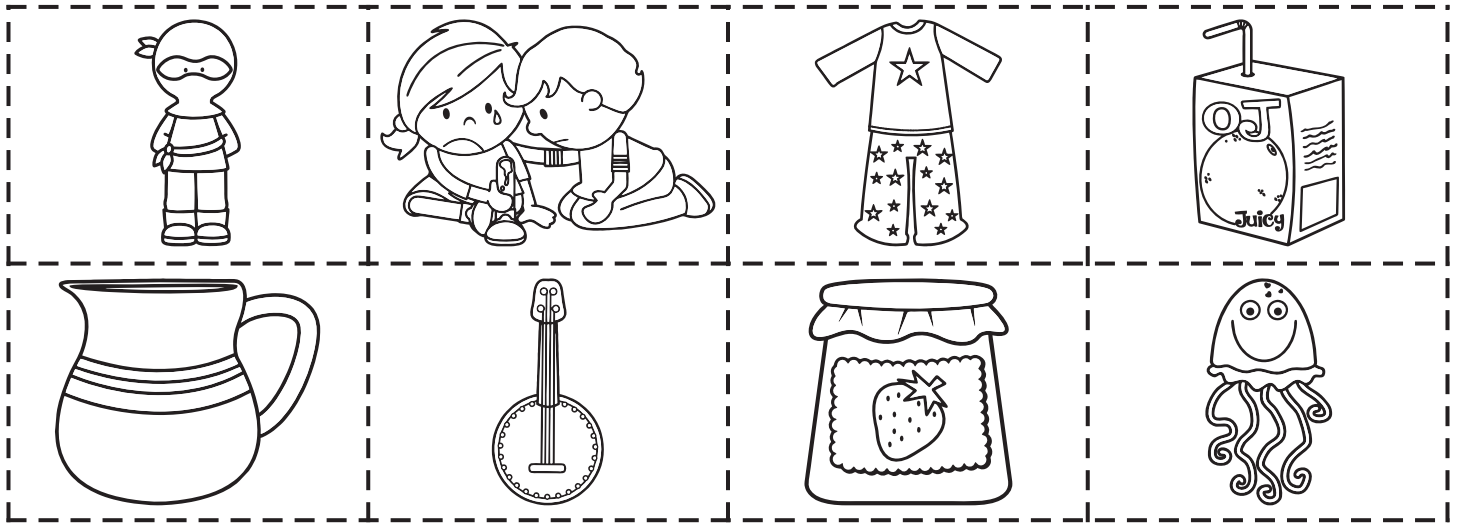
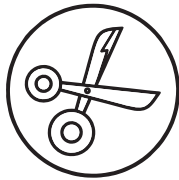



Jill

jumped on the

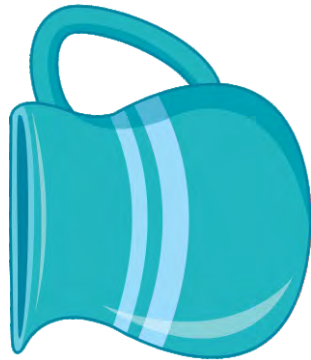

jug.



jellybeans.

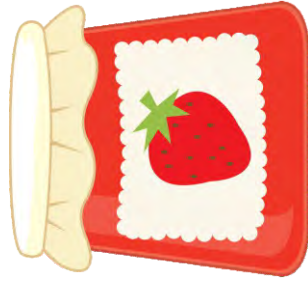

jam.

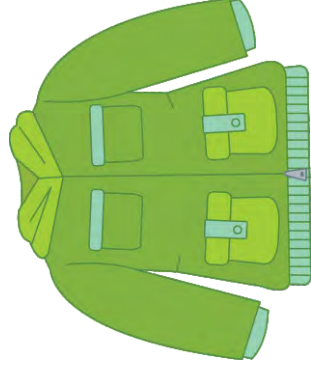

jacket.



jewel.



jar.

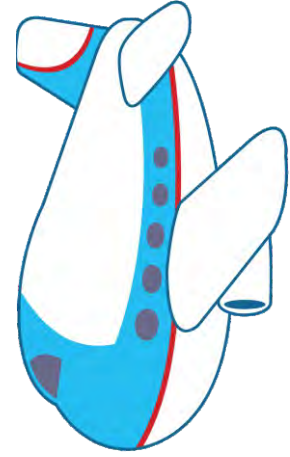

jet.



juice.

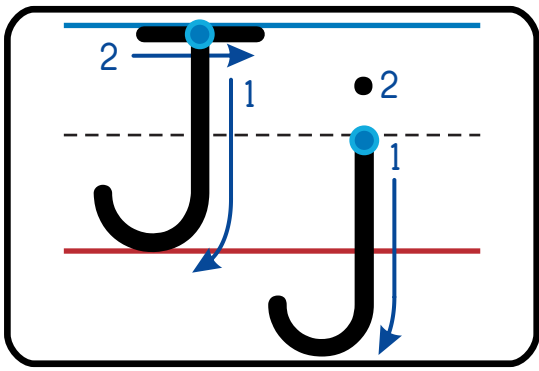

Name:

Build a Sentence

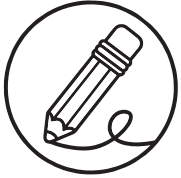

Trace and complete the sentence by writing words from the activity. Draw a picture to match each word.

Jill jumped on the

1 _____

2 _____

3 _____

4 _____

Name _____

By Lavinia Pop © 2013

Glue/Staple

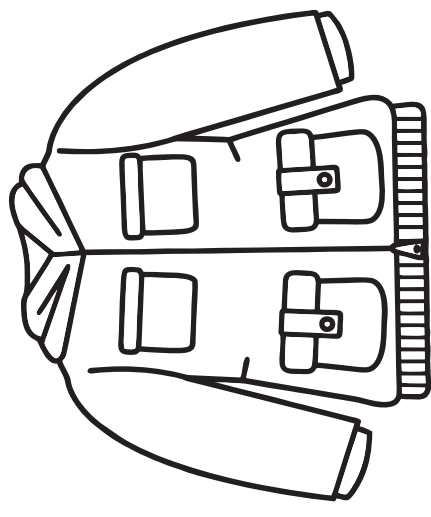

jacket.

I can jump on the

Glue/Staple

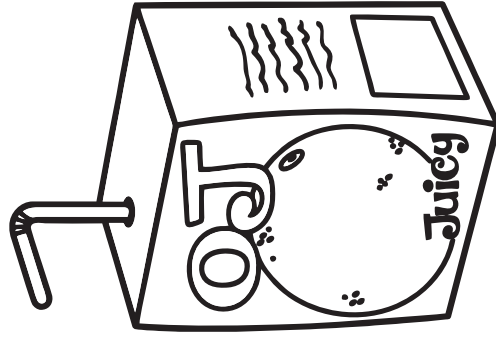

juice.

Glue/Staple

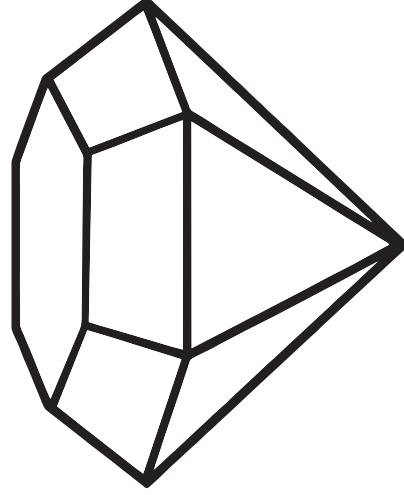

jewel.

Glue/Staple

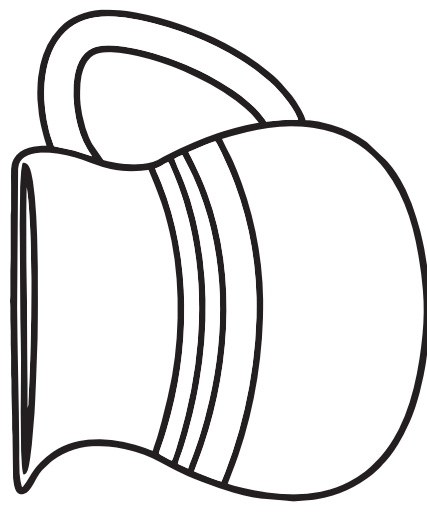

jug.

Glue/Staple

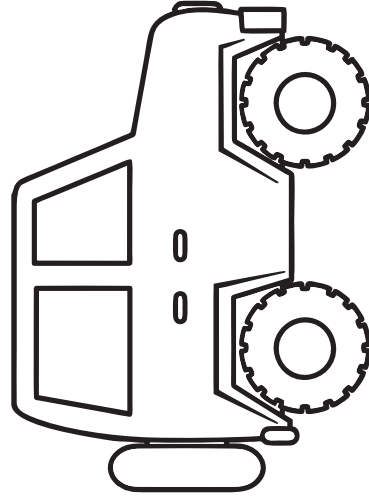

jeep.

Name _____

By Lavinia Pop © 2013

Glue/Staple

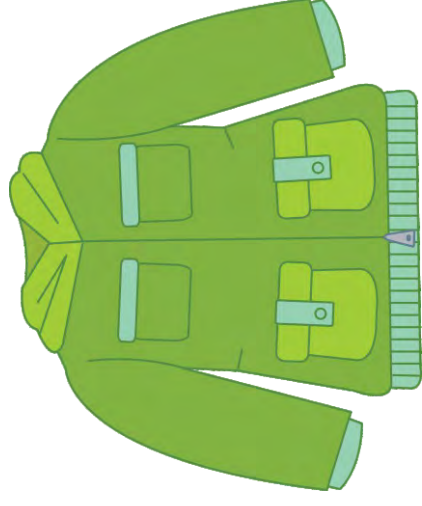

jacket.

I can jump on the

Glue/Staple

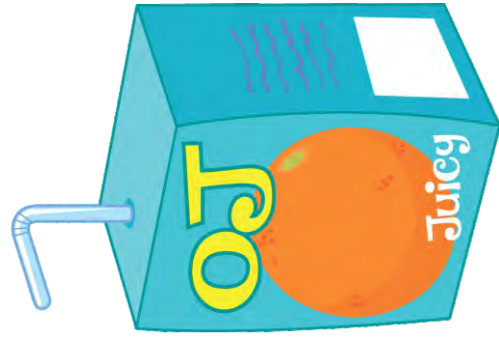

juice.

Glue/Staple

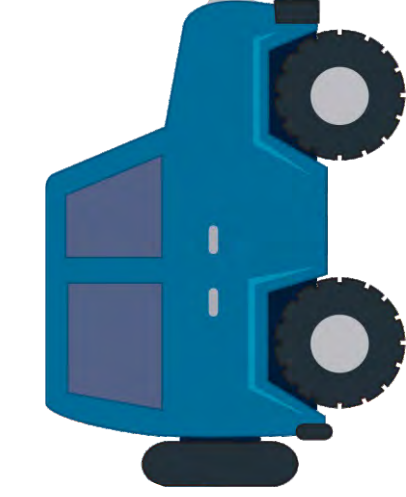

jeep.

Glue/Staple



jug.

jewel.



Name:

Letter Jj

Write a sentence from your flip book using one word that begins with the letter “j”.

The “j” word I chose is...

Another “j” word is...

A picture of my sentence:

Name: _____

Use your flip book to help you label the pictures.

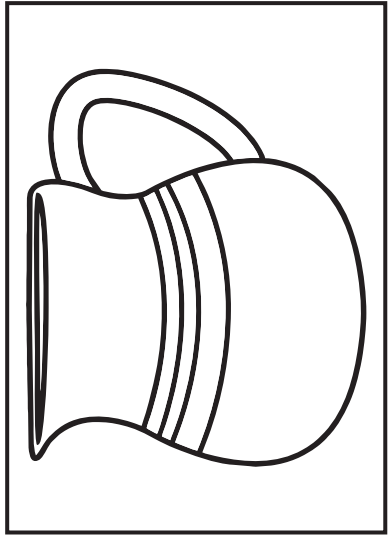
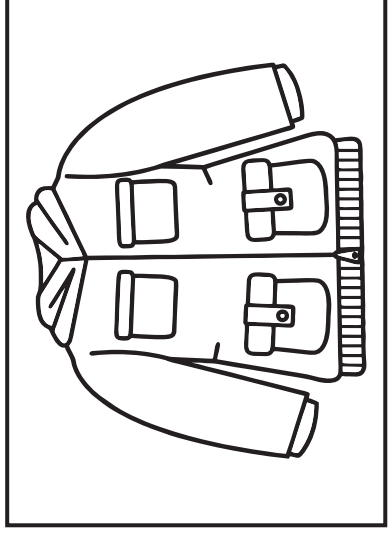
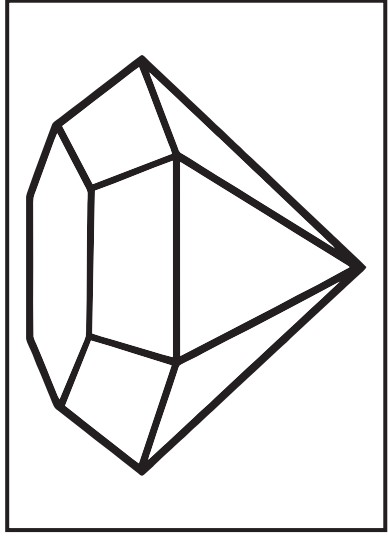
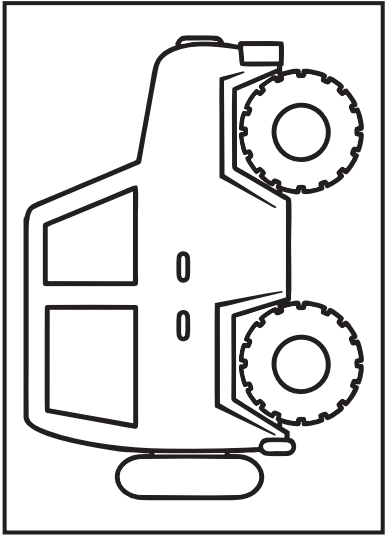
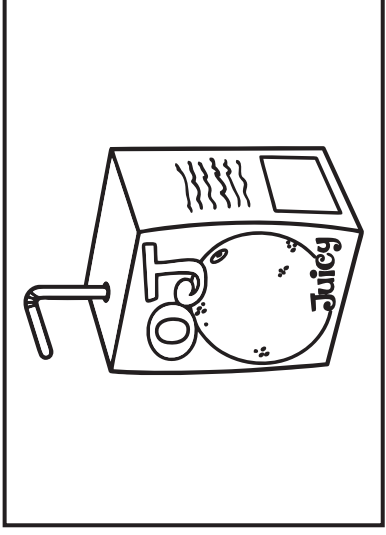
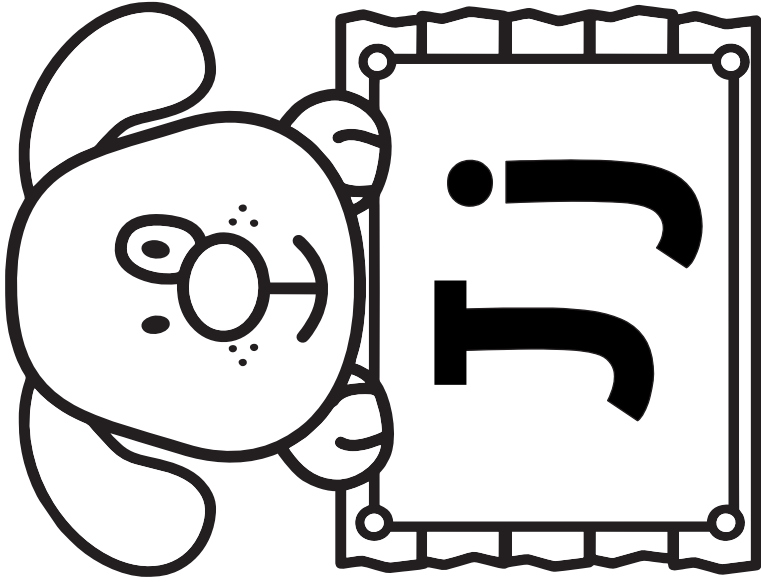

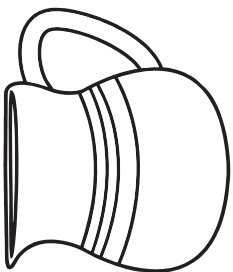
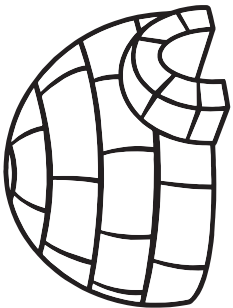
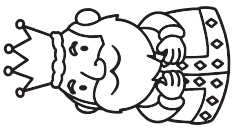
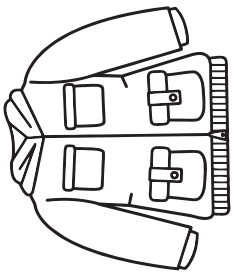
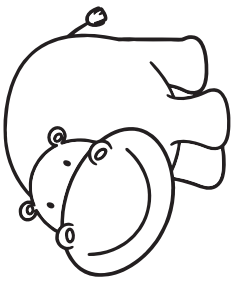

Circle the pictures that begin with "j".

Color J and j.

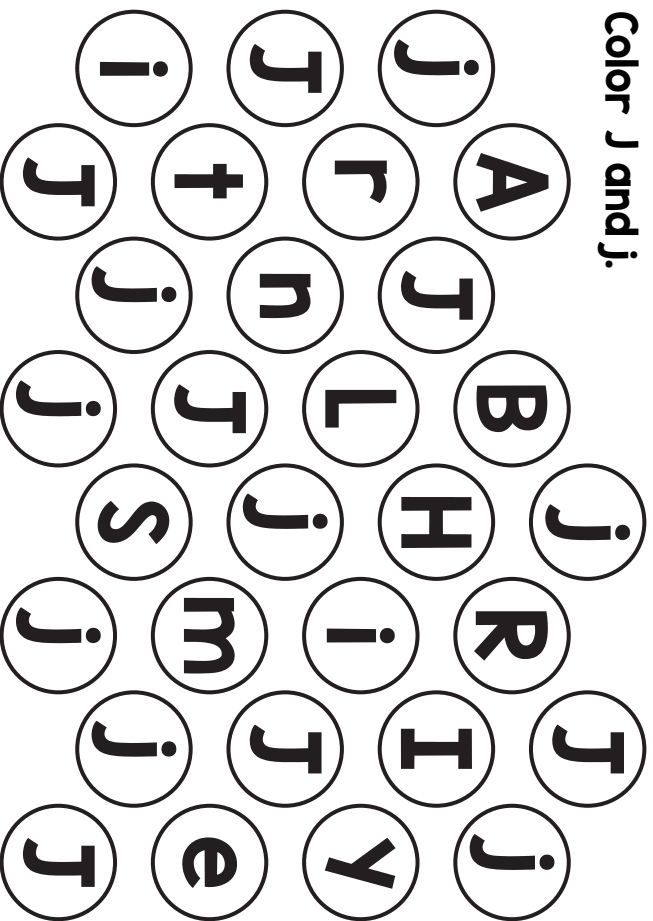

Trace the upper and lower case letters.

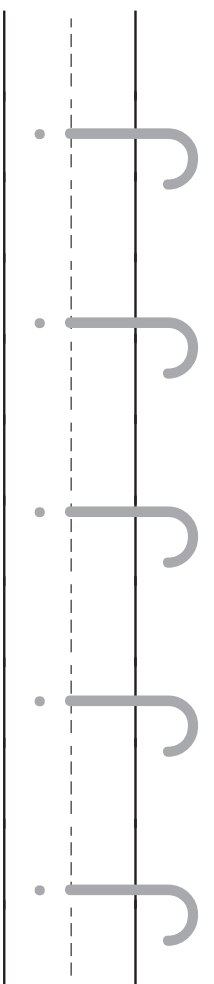
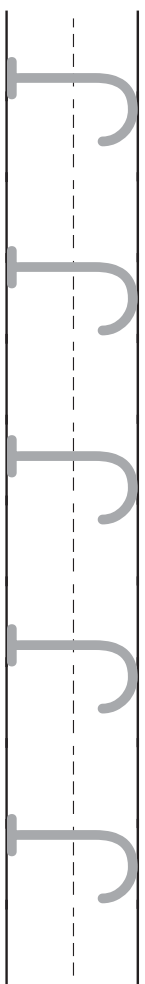

M Y

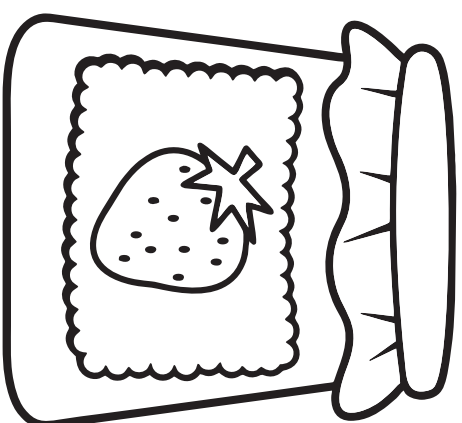
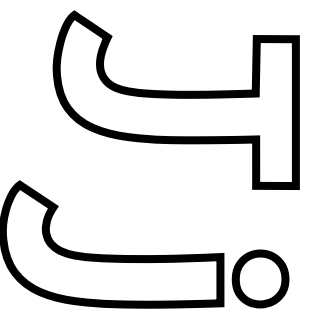

BOOK

Name:

ALPHABET READER

J j

Name

By Lavinia Pop © 2013

ALPHABET READER

J j

Name

By Lavinia Pop © 2013

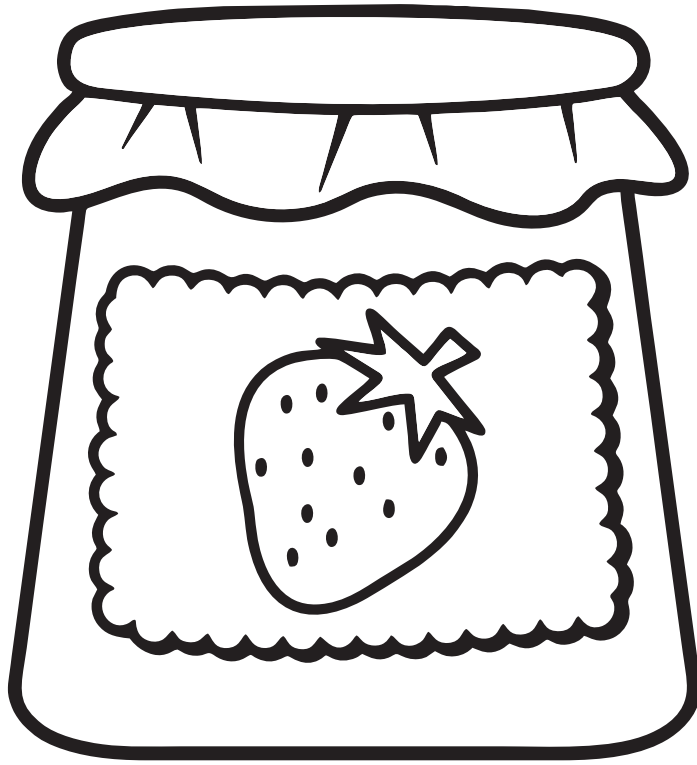

This is his jam.

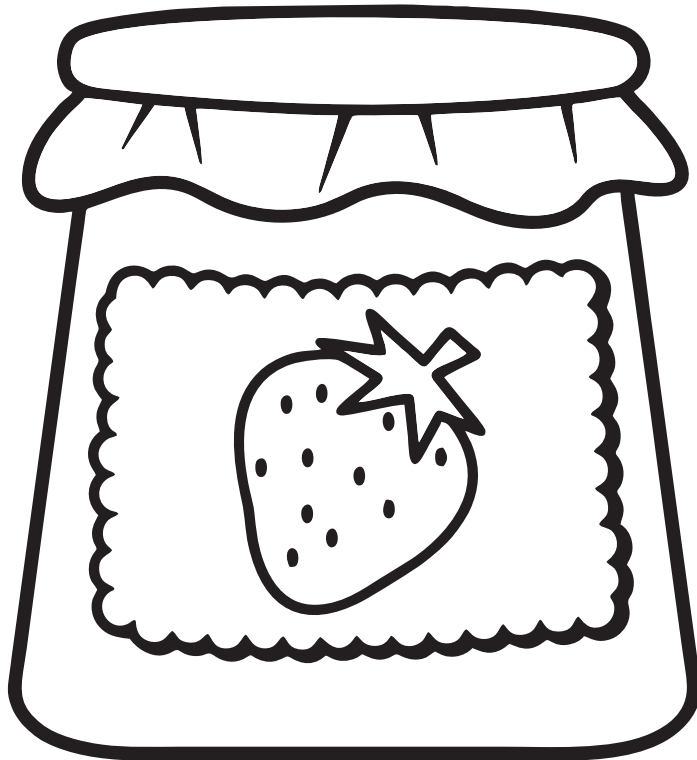

This is his jam.



This is his jet.



This is his jet.



This is his job.



This is his job.



This is his jug.



This is his jug.

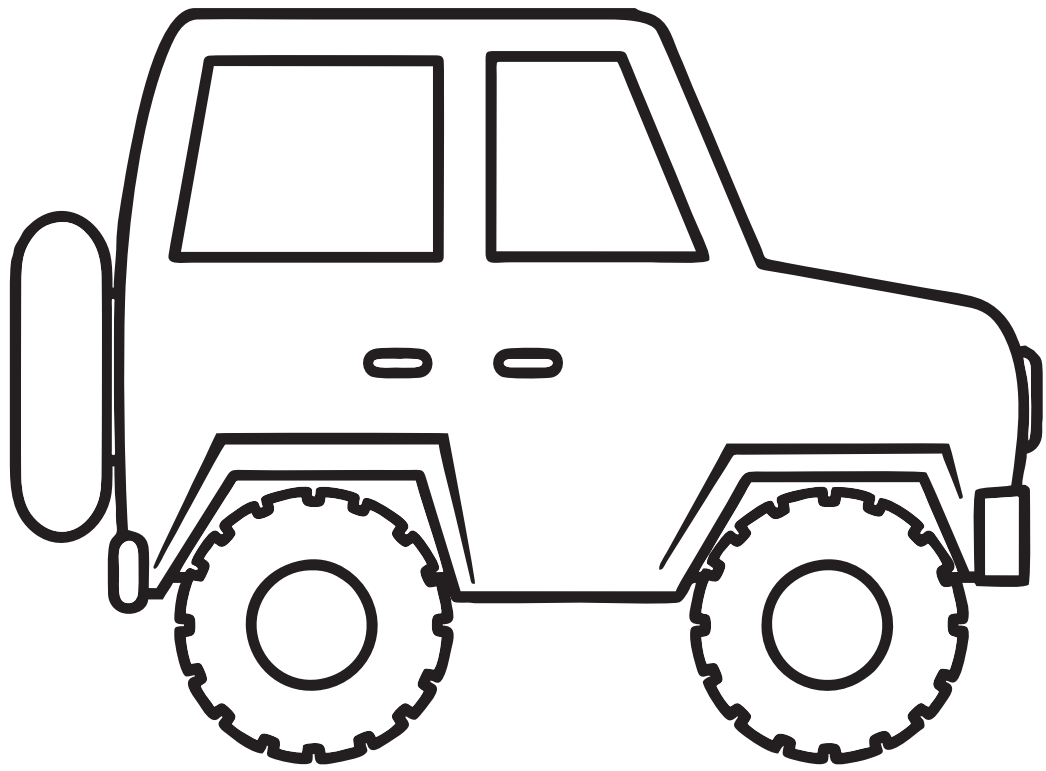

This is his jeep.

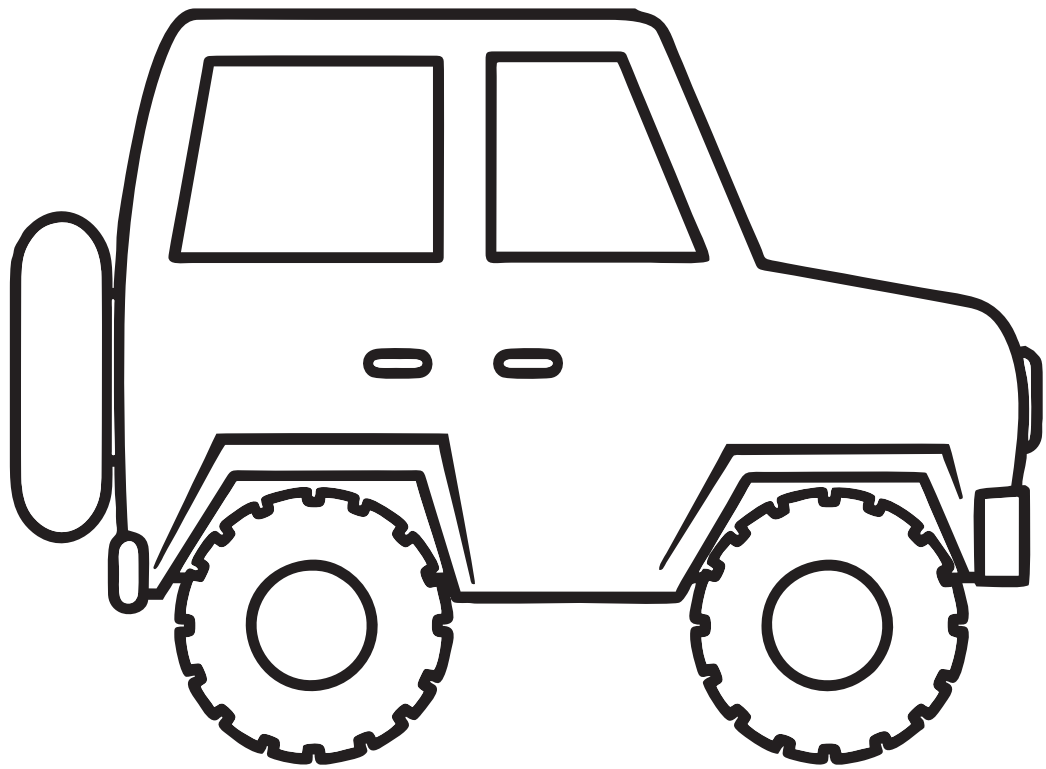

This is his jeep.

ALPHABET READER



Name

By Lavinia Pop © 2013

ALPHABET READER



Name

By Lavinia Pop © 2013



This is his jam.



This is his jam.

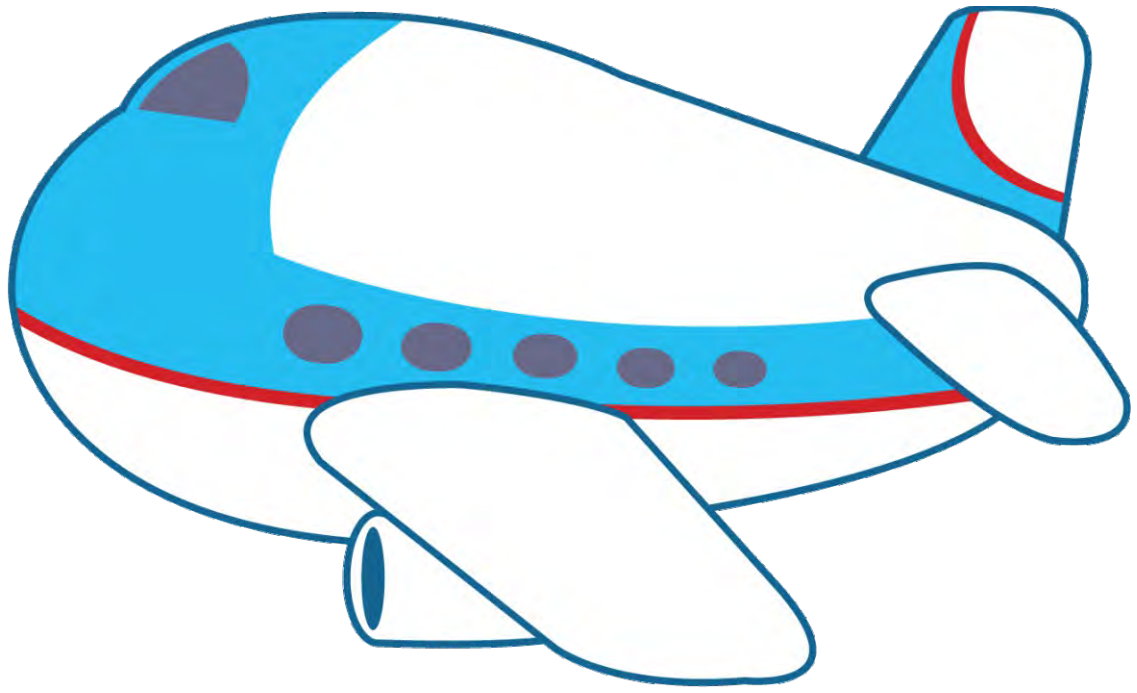

This is his jet.



This is his jet.



This is his job.



This is his job.



This is his jug.



This is his jug.

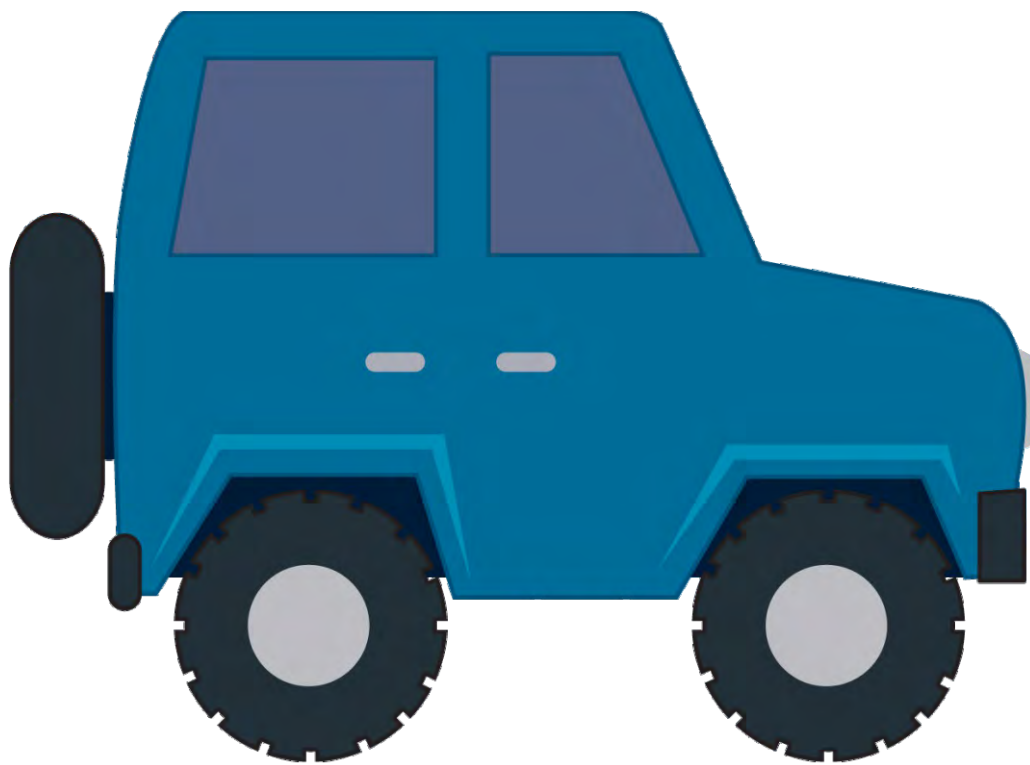

This is his jeep.

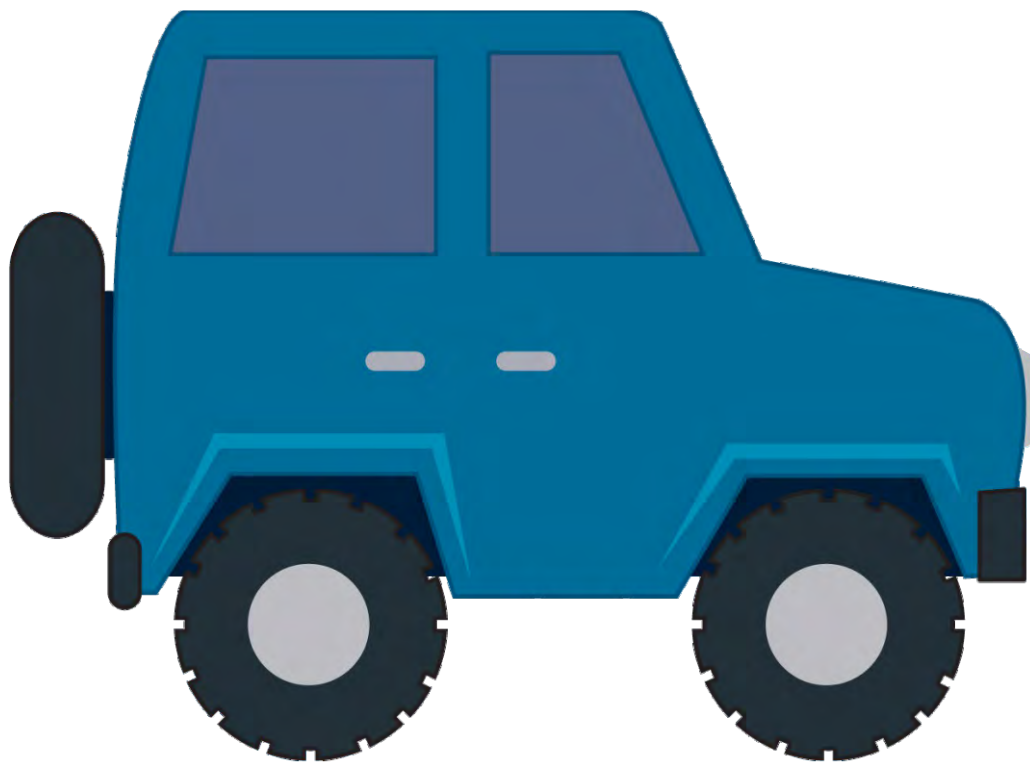

This is his jeep.

M I S S I N G L E T T E R S

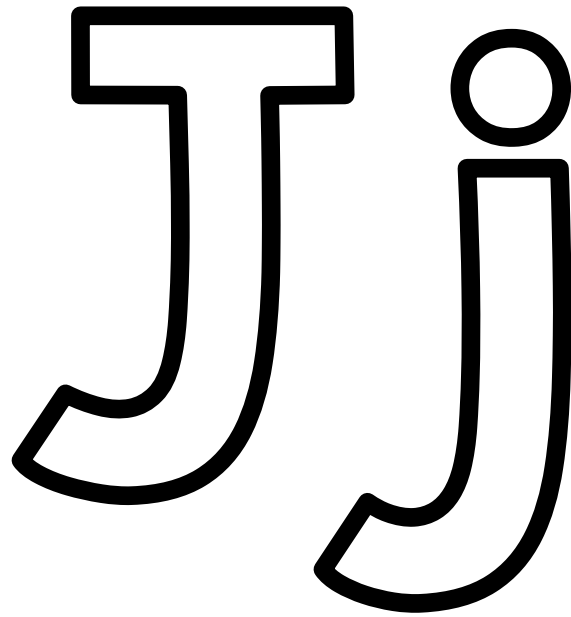

Name

By Lavinia Pop © 2013

M I S S I N G L E T T E R S

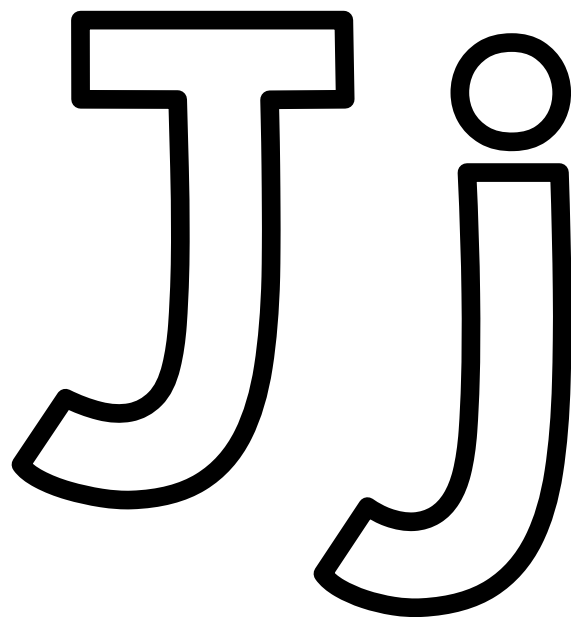

Name

By Lavinia Pop © 2013

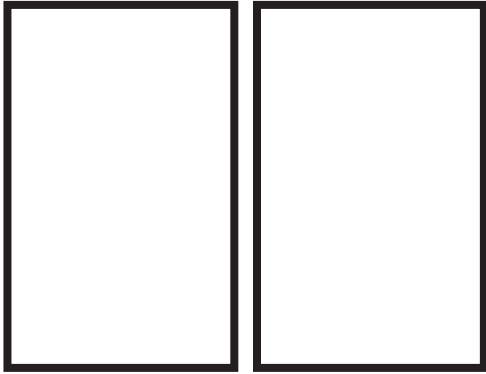
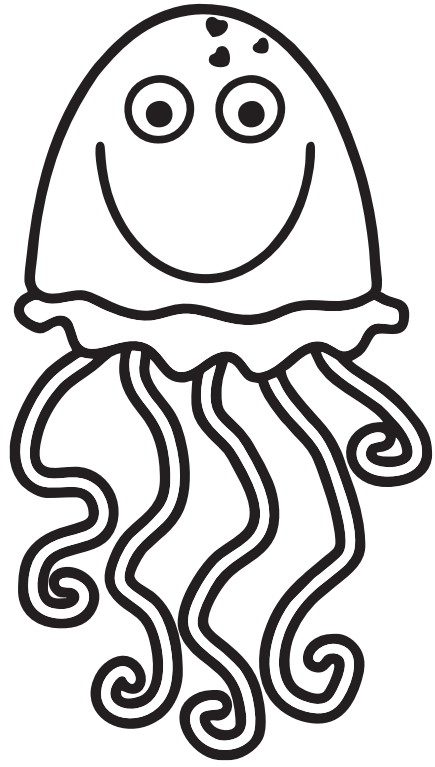

is for jellyfish.

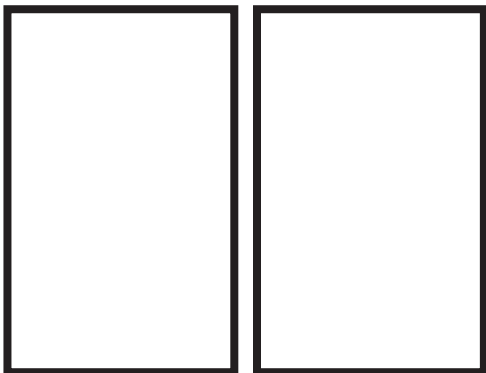
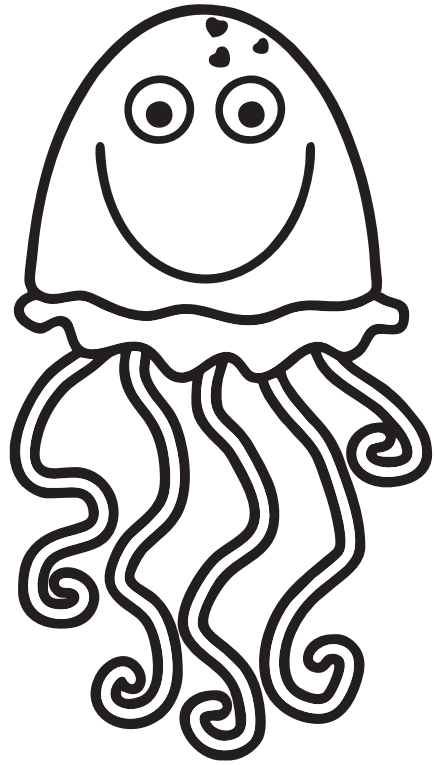

is for jellyfish.

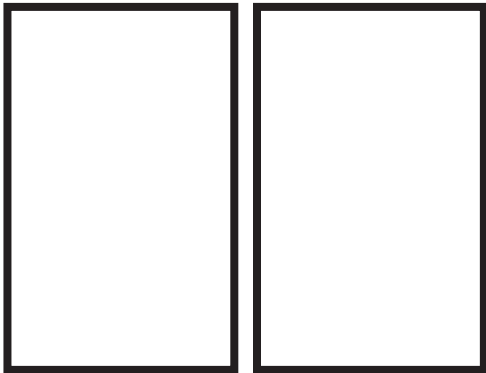
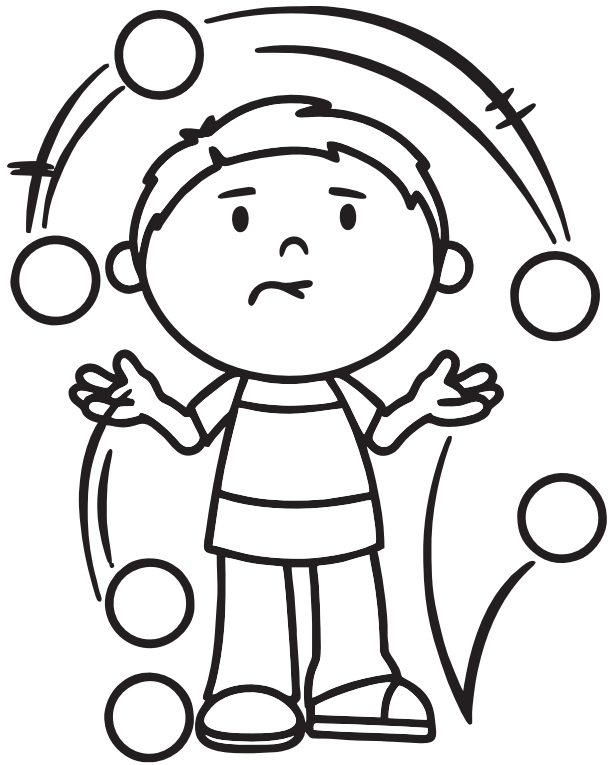

is for juggle.

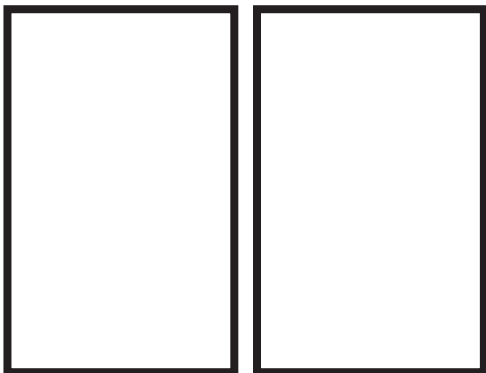

is for juggle.

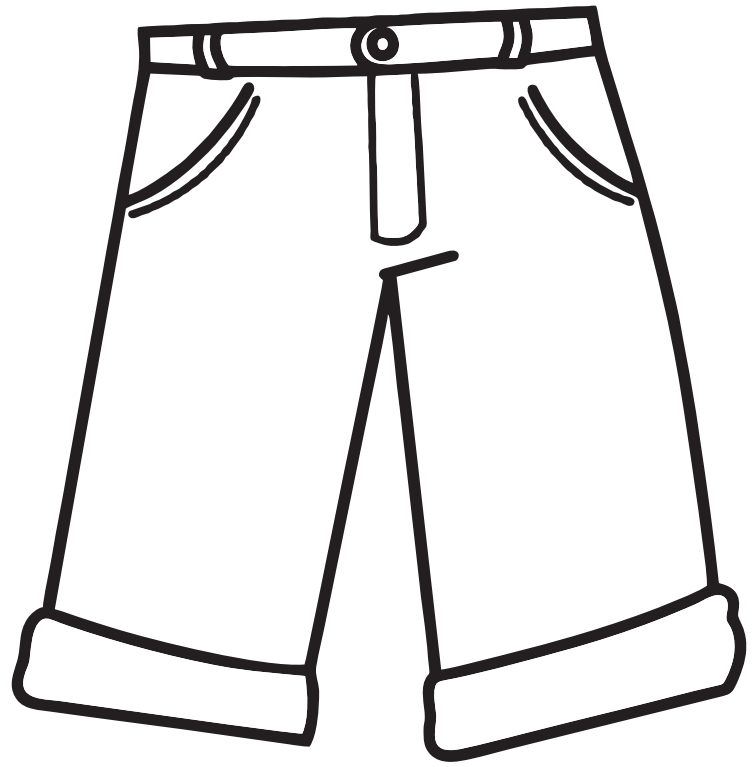

is for jeans.

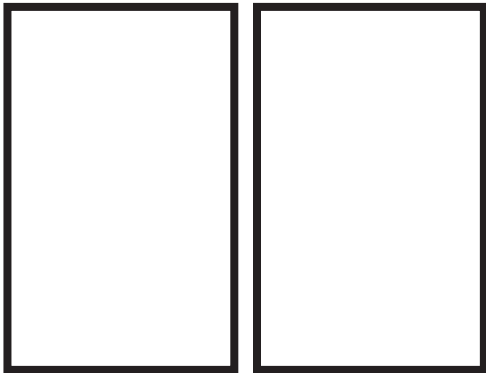

is for jeans.

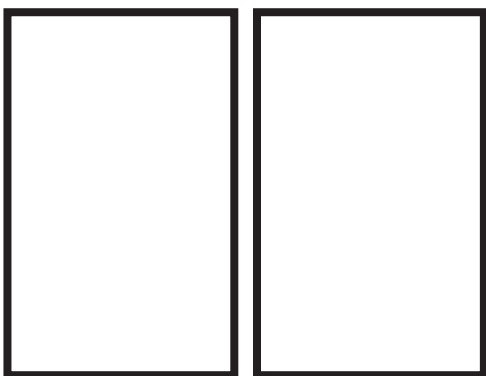

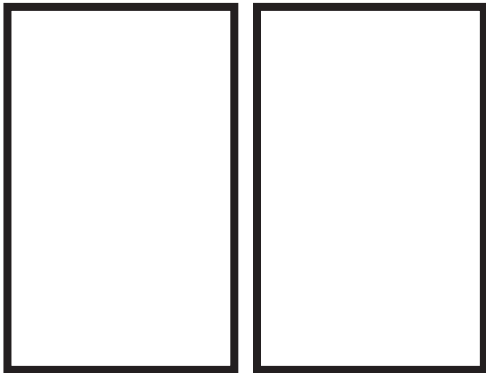

is for jump.

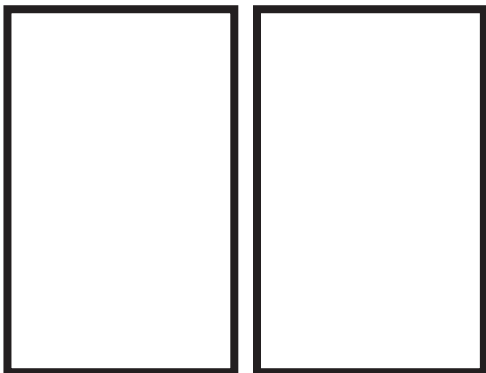

is for jump.

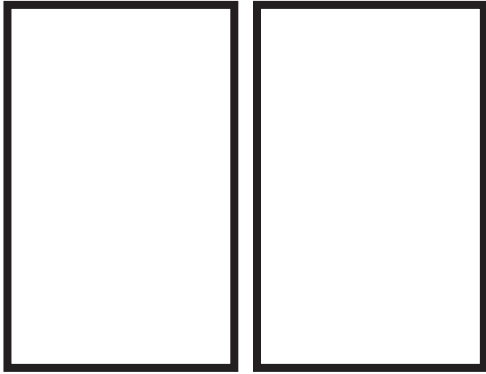

is for jar.

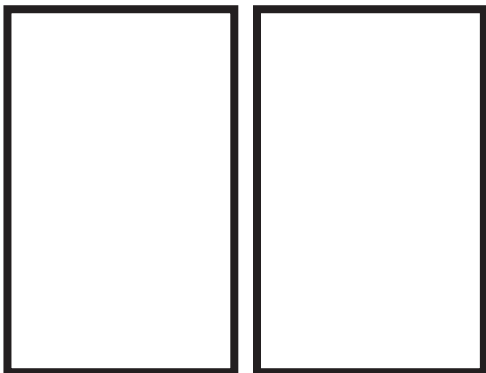

is for jar.

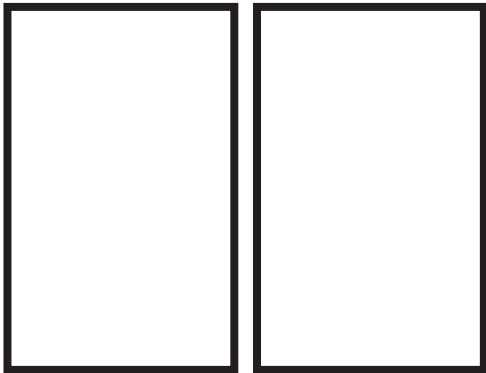

is for job.

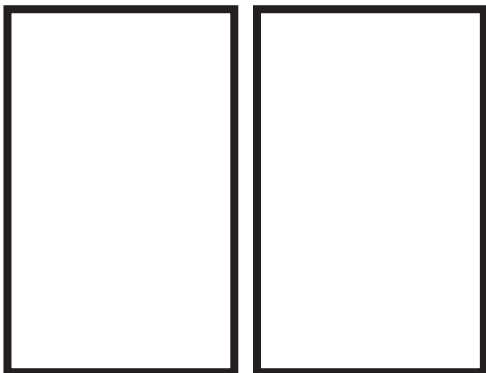

is for job.

j

J j

J j

J j

J j

J j

J j

J j

J j

J j

J j

J j

J j

J j

J j

J j

J j

J j

P i c t u r e S c r a m b l e

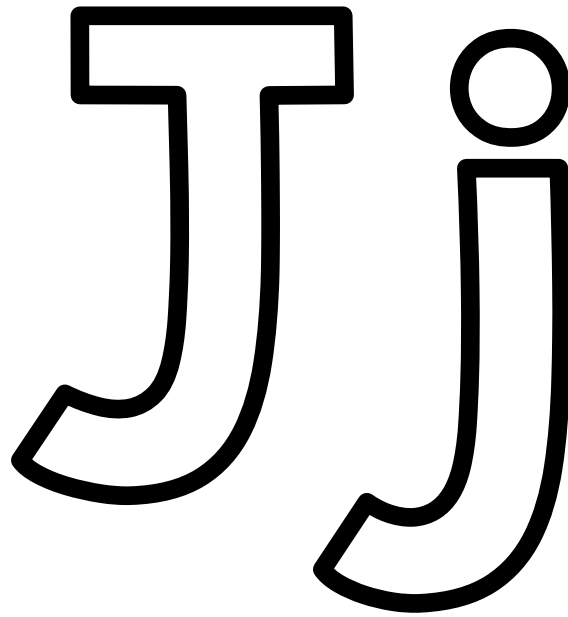

jab
jam
jet
jig
jot
jug

Name

By Lavinia Pop © 2013

P i c t u r e S c r a m b l e

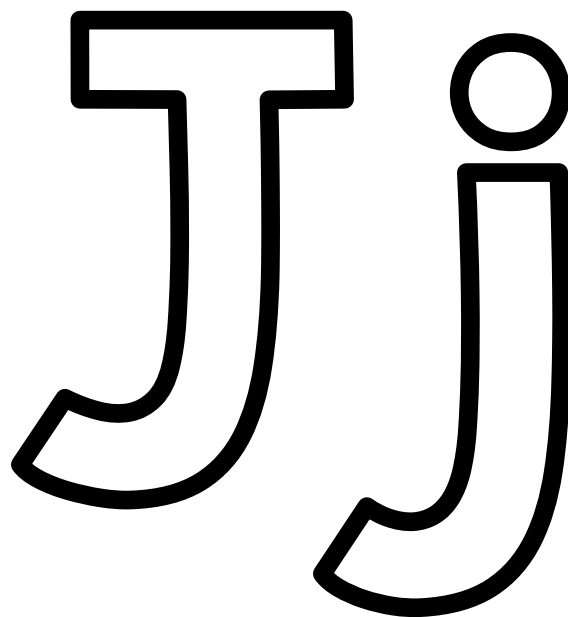

jab
jam
jet
jig
jot
jug

Name

By Lavinia Pop © 2013

jab

jab

Handwriting practice lines for the word 'jab'.

--	--	--

jab

jab

Handwriting practice lines for the word 'jab'.

--	--	--

jam

jam

Blank handwriting lines for practice.

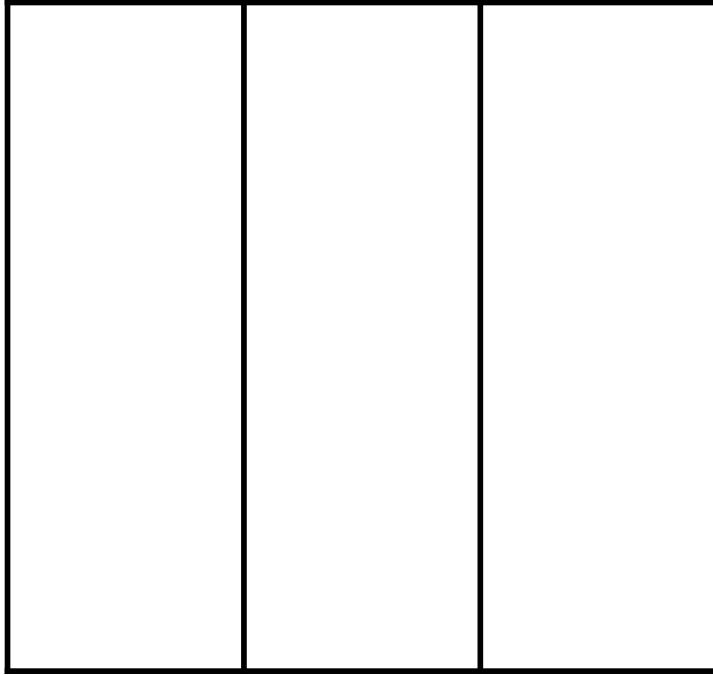

jam

jam

Blank handwriting lines for practice.

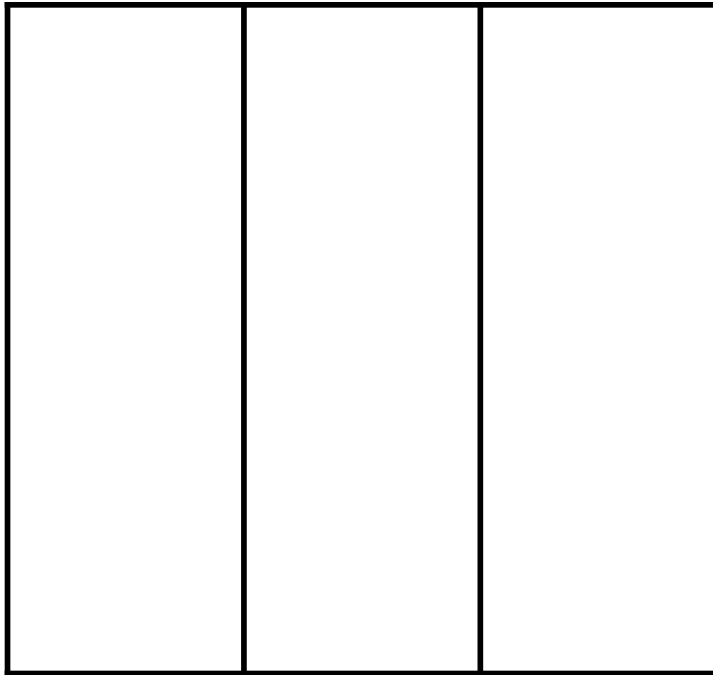

jet

jet

--	--	--

jet

jet

--	--	--

jig

jig

--	--	--

jig

jig

--	--	--

jot

jot

Blank handwriting practice lines consisting of a solid top line, a dashed middle line, and a solid bottom line.

--	--	--

jot

jot

Blank handwriting practice lines consisting of a solid top line, a dashed middle line, and a solid bottom line.

--	--	--

jug

jug

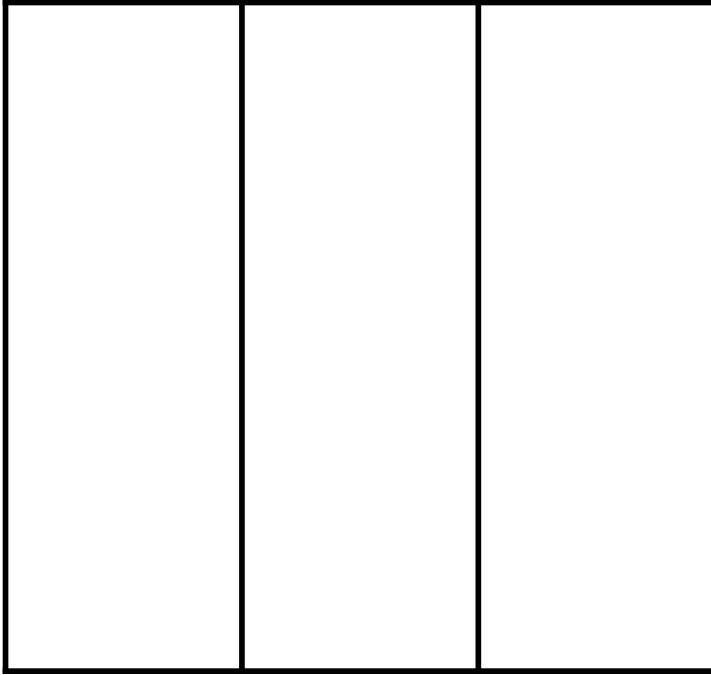

jug

jug

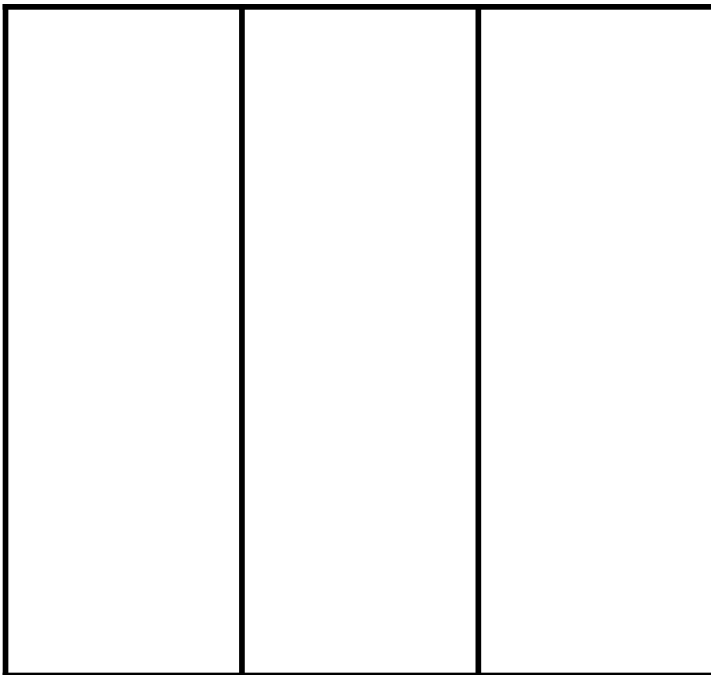

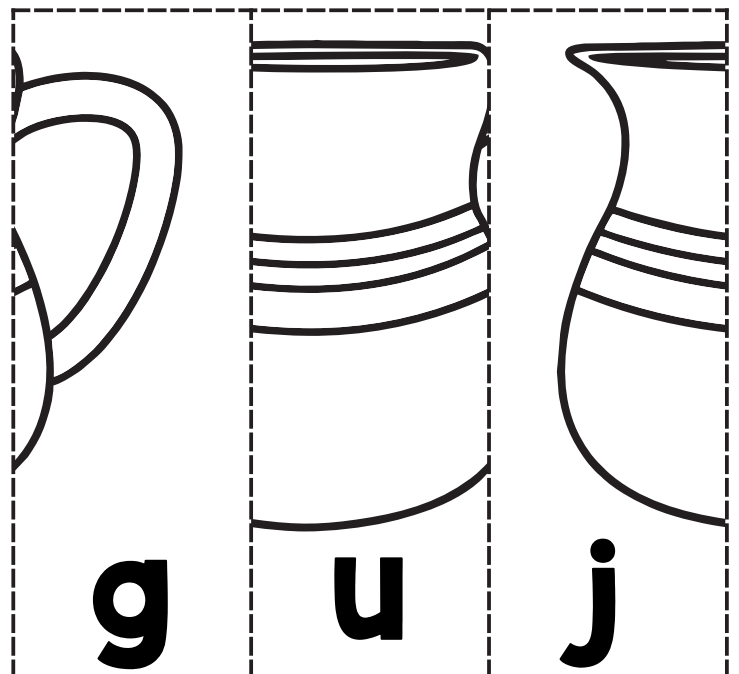
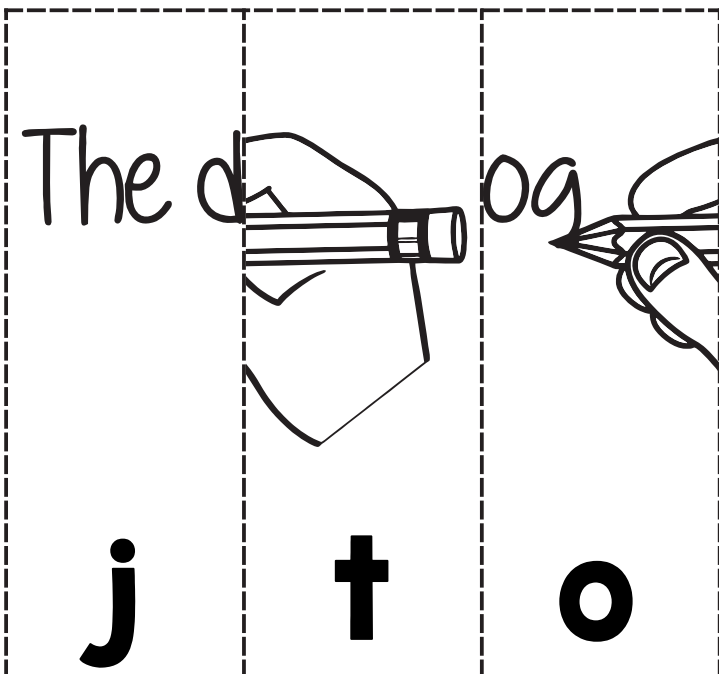
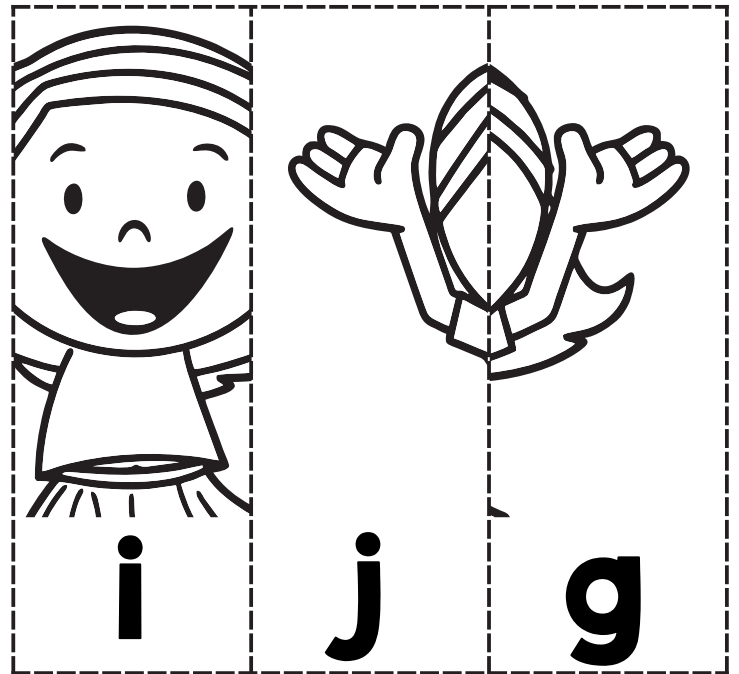
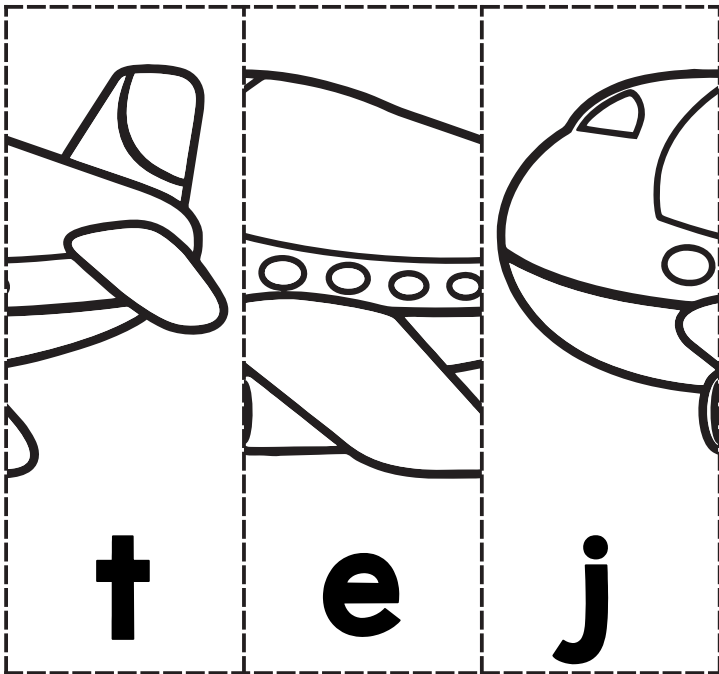
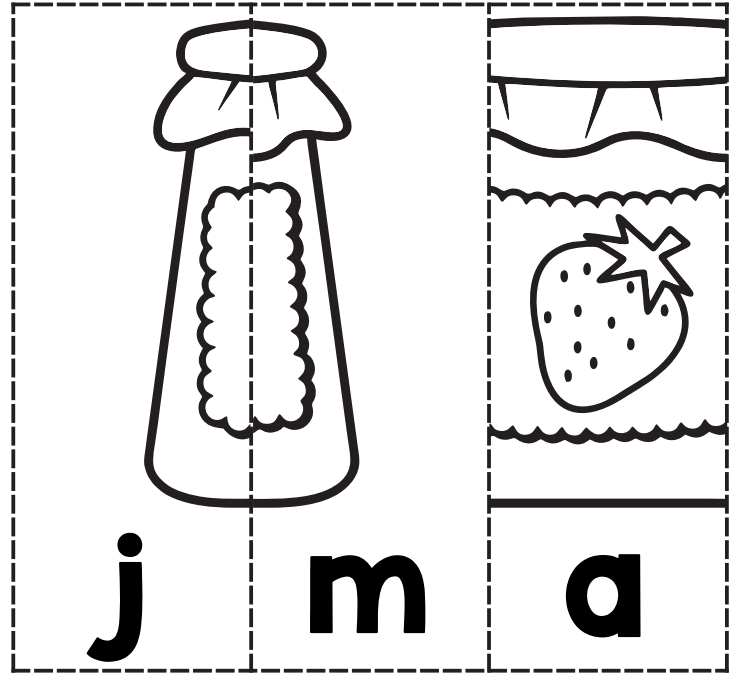
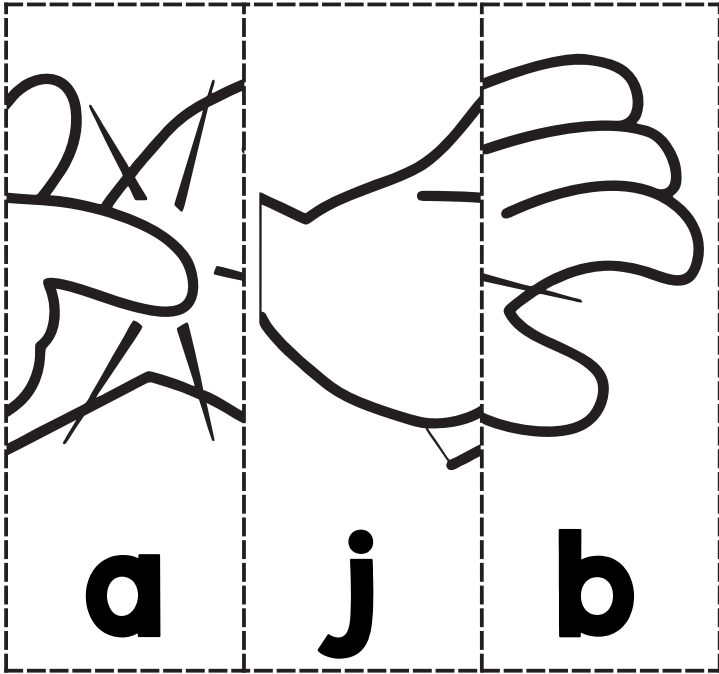

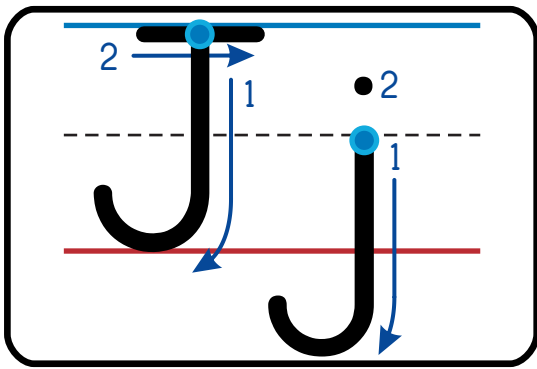

Name:

Letter Maze

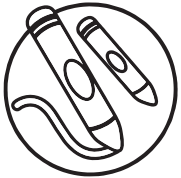

Help the jellyfish get to the jellybeans by following the J-j-J-j pattern through the maze.



J	j	J	f	Q	f	R
r	W	j	F	m	N	u
K	z	J	d	e	x	C
x	G	j	J	j	B	p
y	f	s	T	J	a	k
I	P	O	a	j	b	z
N	x	s	e	J	j	O
v	c	v	V	m	J	r
S	t	P	u	r	j	J



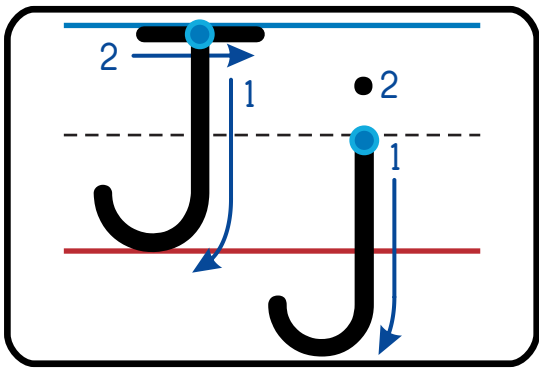

Name:

Font Maze

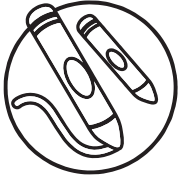

Follow the different Jj's through the maze.

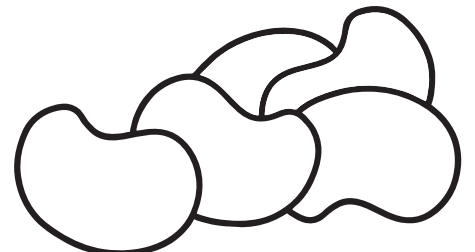
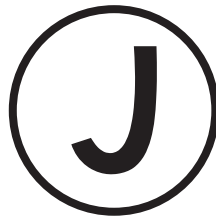
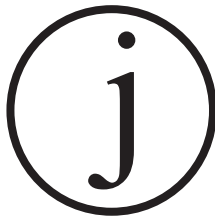
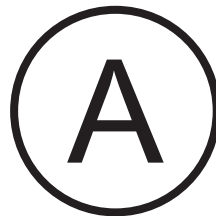
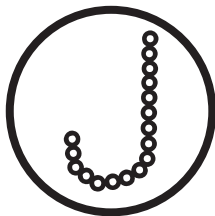
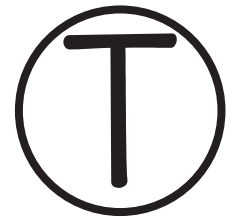
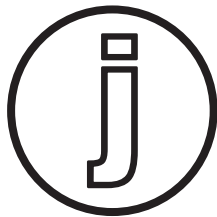
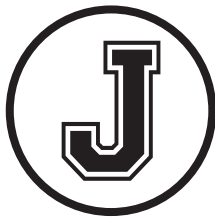
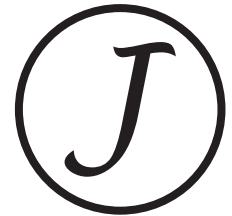
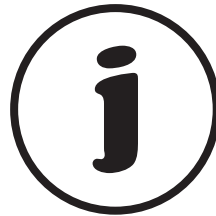
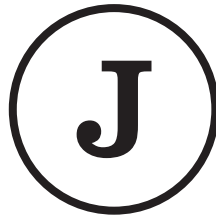
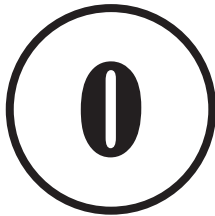
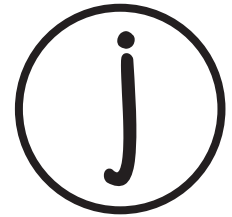
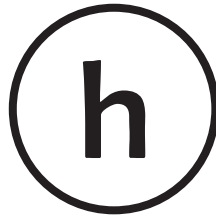
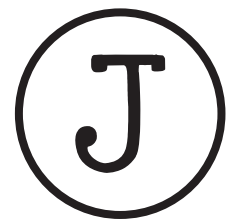
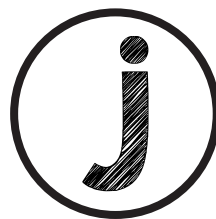
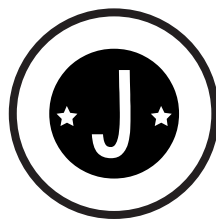
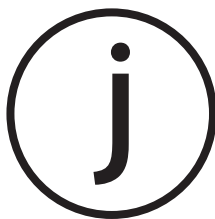
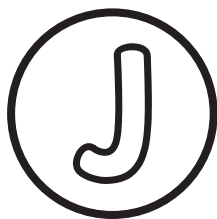

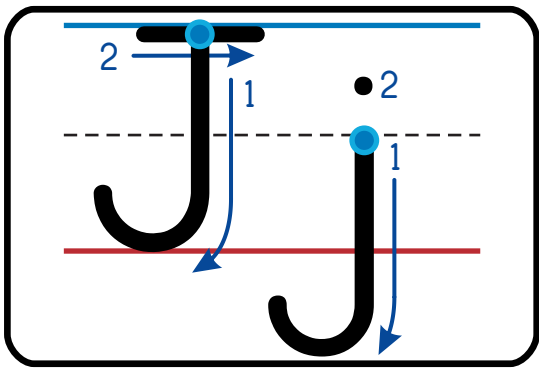

Name:

Hidden Letter

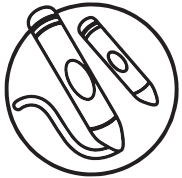

Color the sections using the code to reveal the hidden letter.

J



j

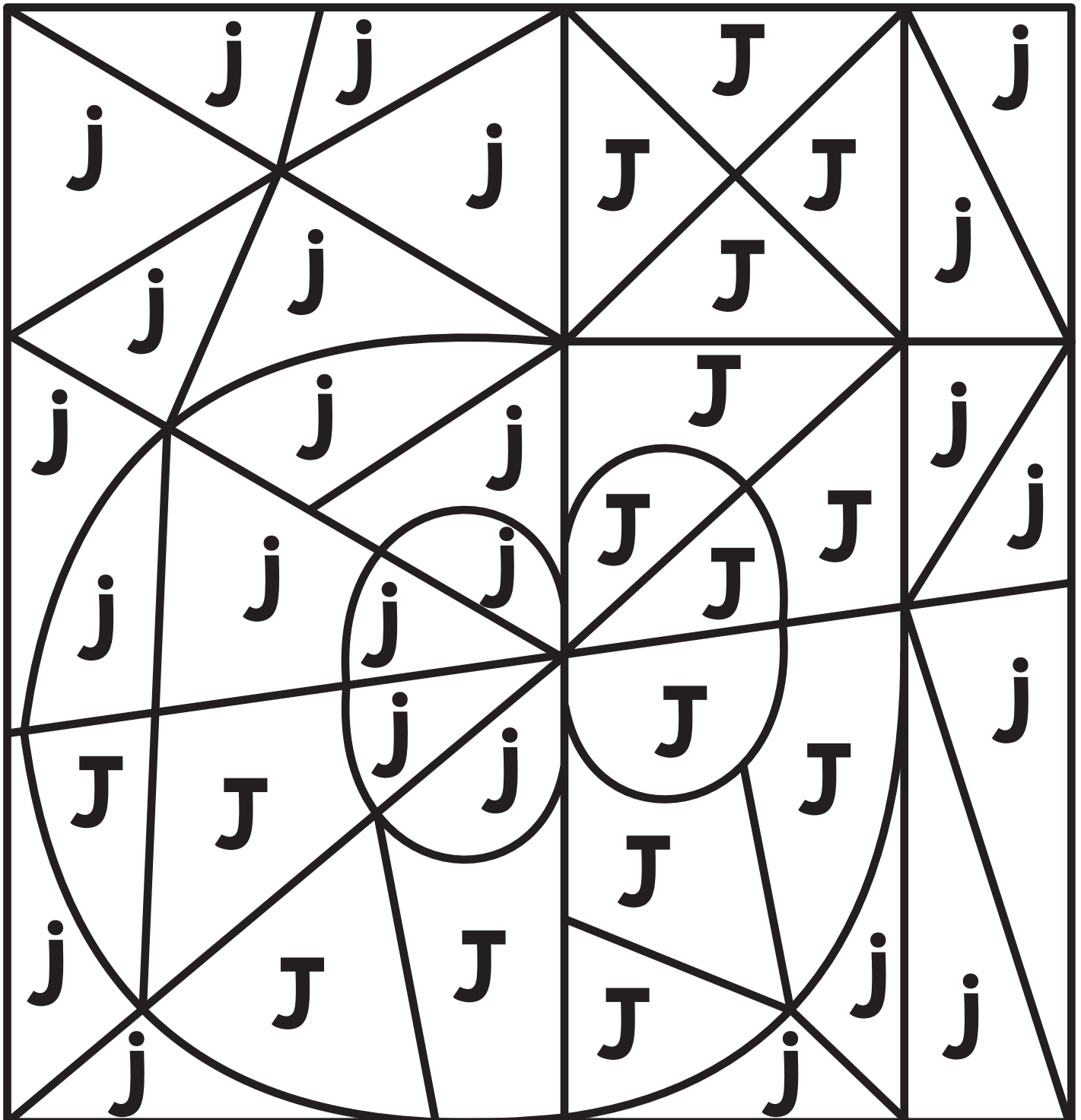

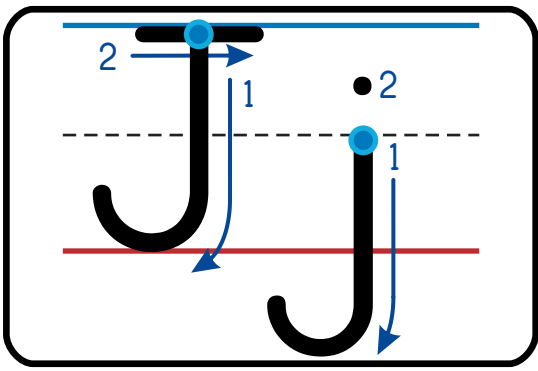

Name:

Hidden Letter

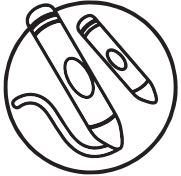

Color the sections using the code to reveal the hidden letter.

J



j



J	J	j	J	J
J	J	j	J	J
J	J	j	J	J
J	J	j	J	J
J	J	j	J	J
J	J	j	J	J
J	J	j	J	J

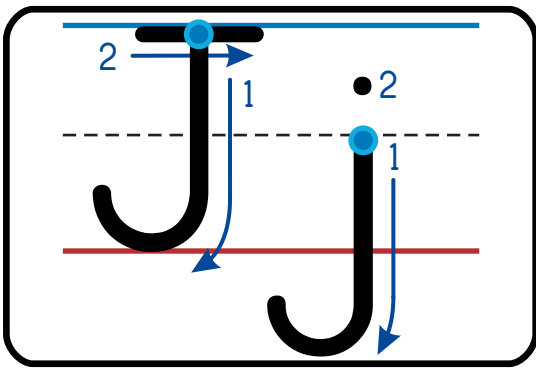

Name:

Beginning Sounds

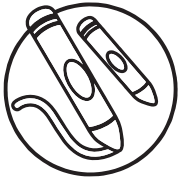

Color the pictures that begin with the Jj sound.

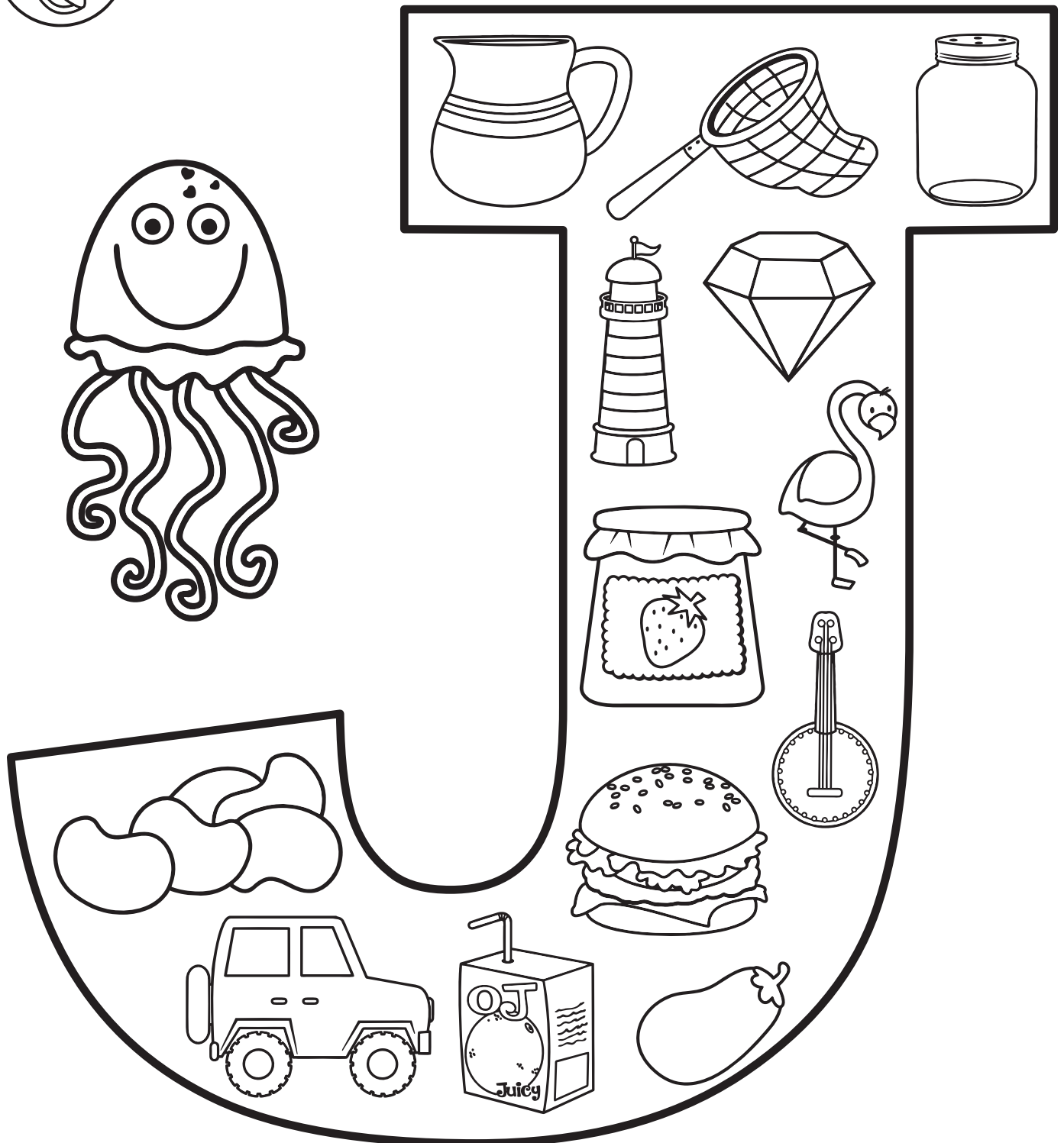

Name: _____

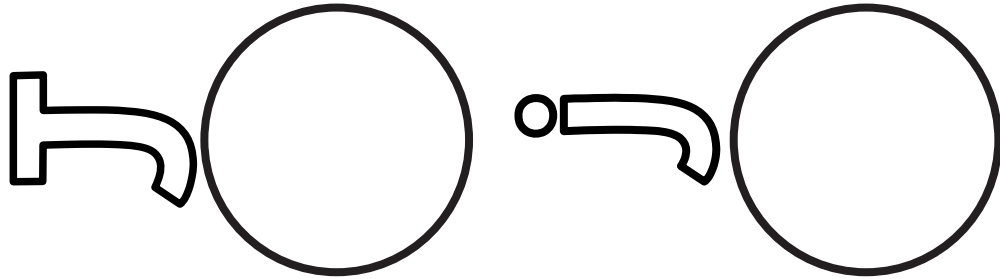
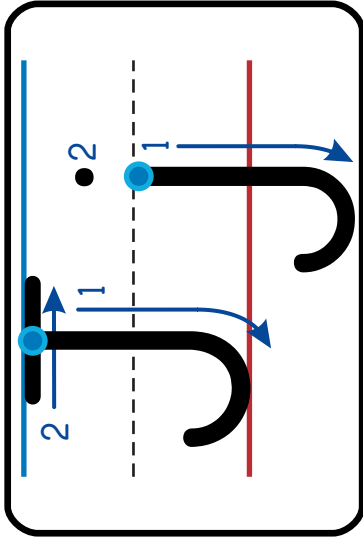

Letter Find

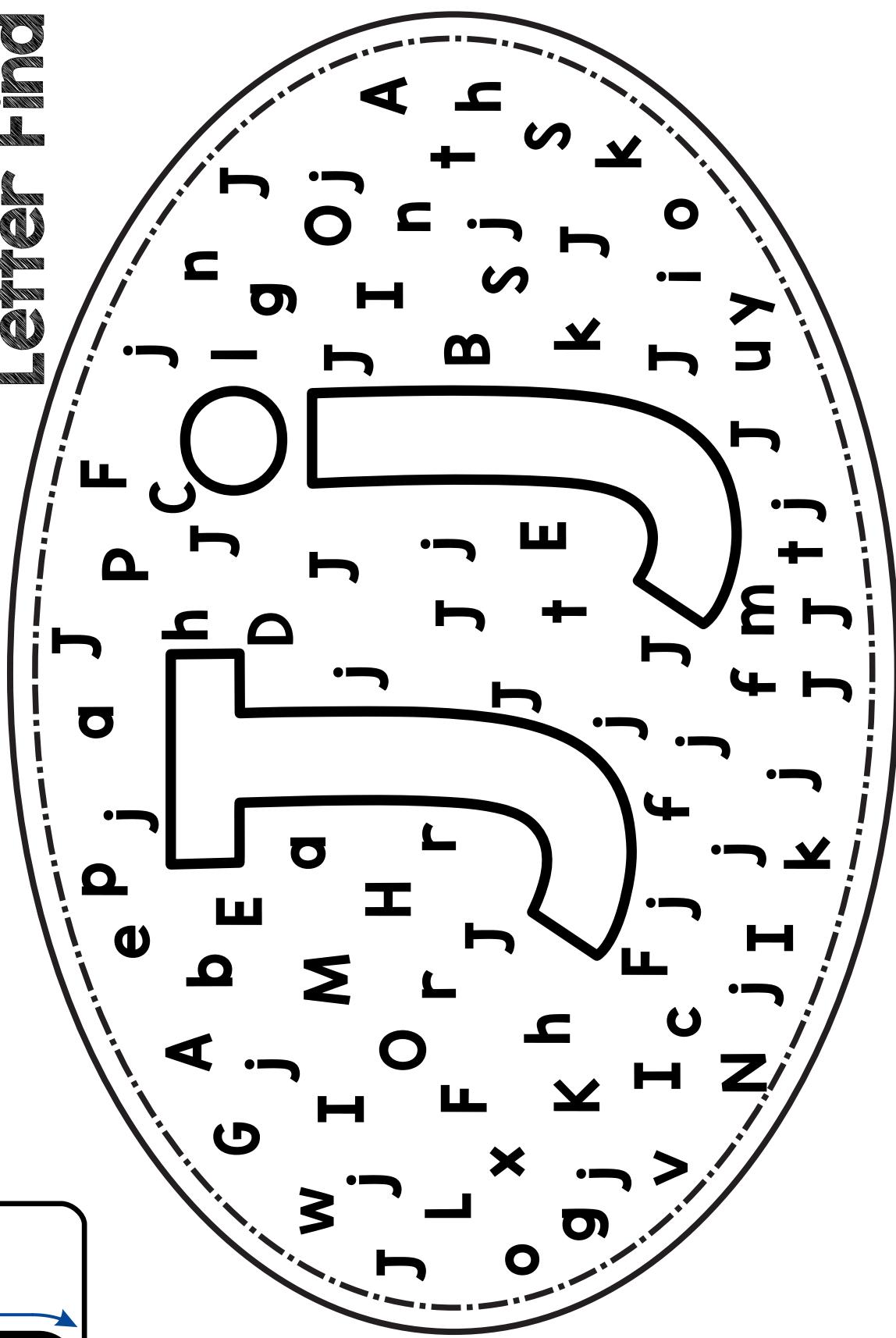

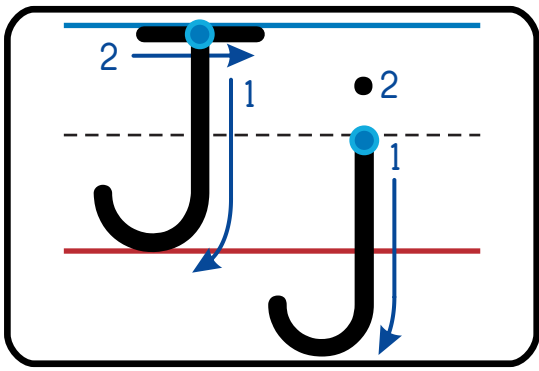

Name:

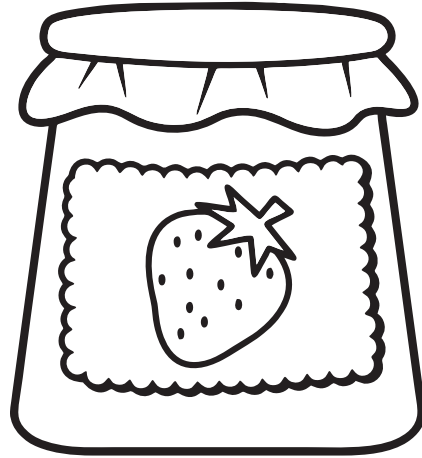

Handwriting

jam

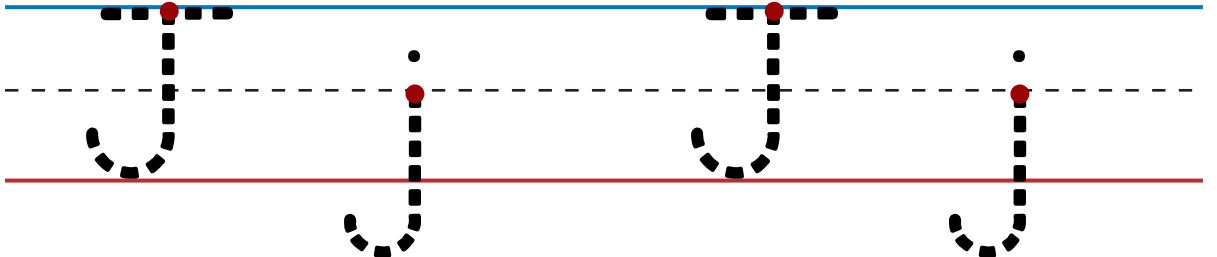
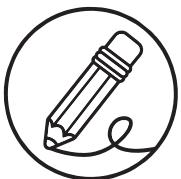
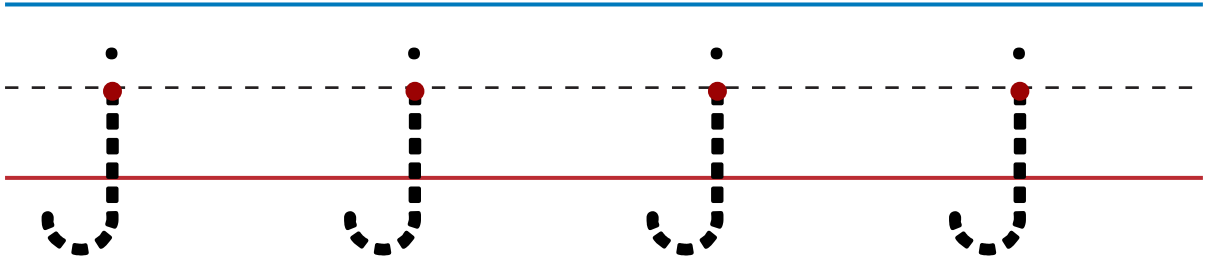
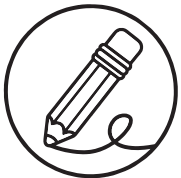
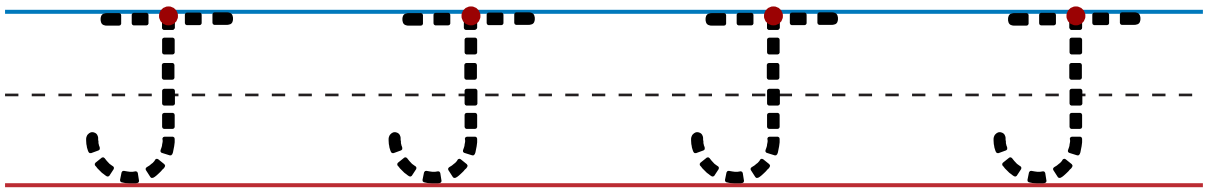
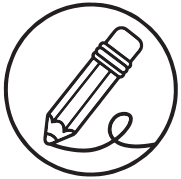
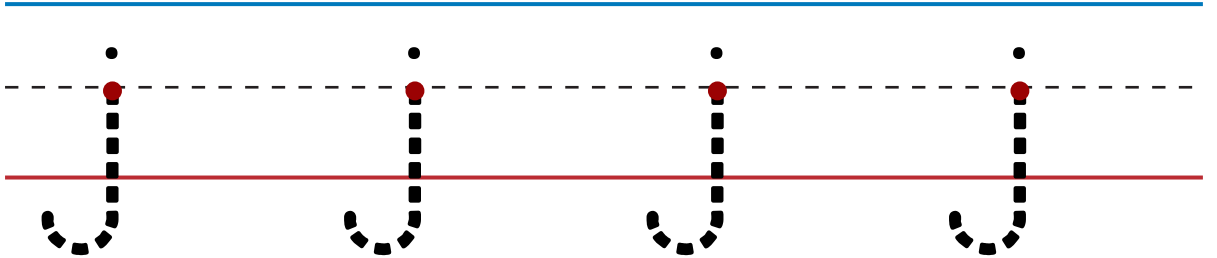
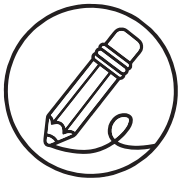
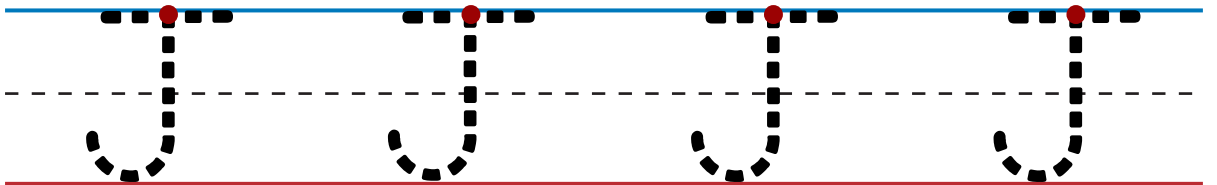
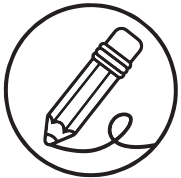

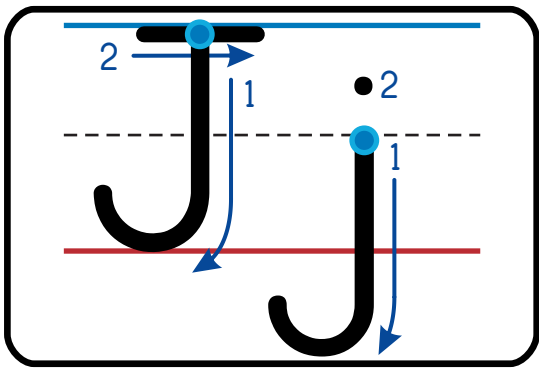

Name:

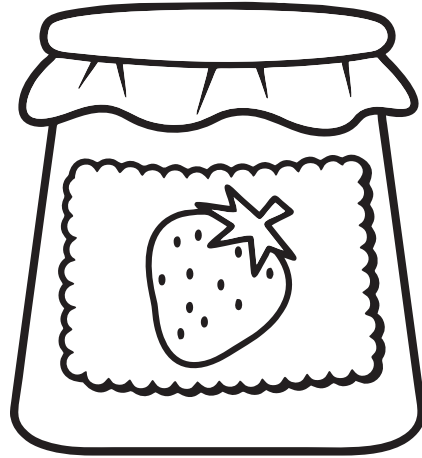

Handwriting

jam

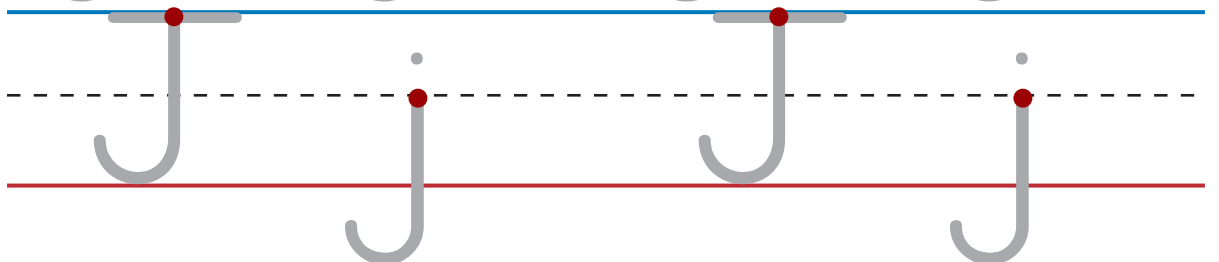
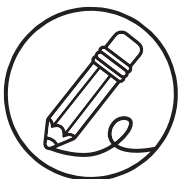
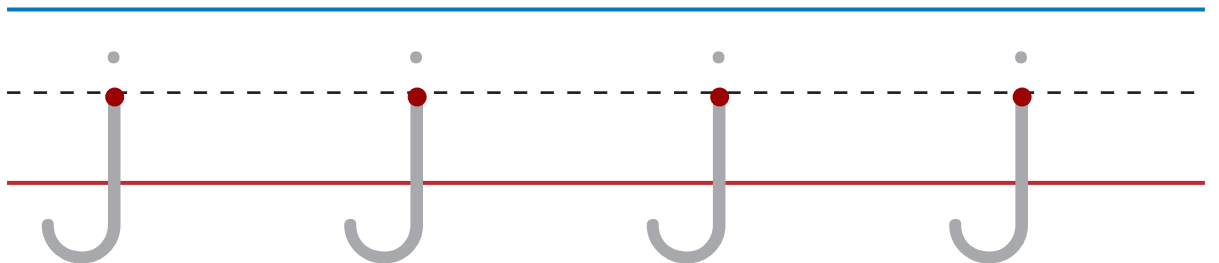
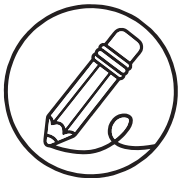
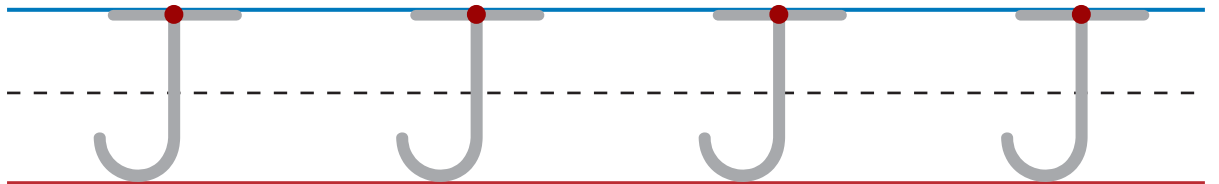
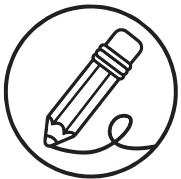
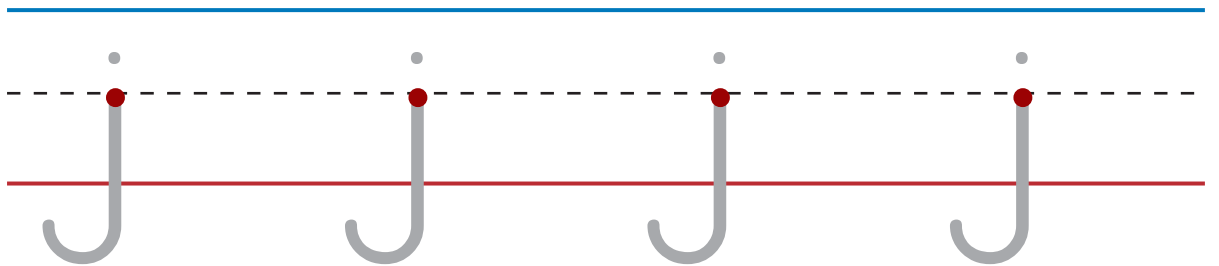
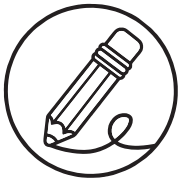
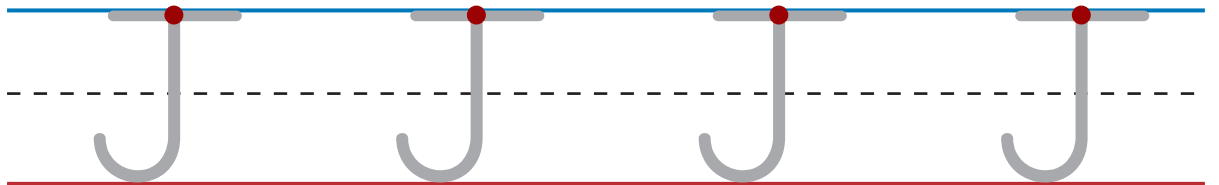
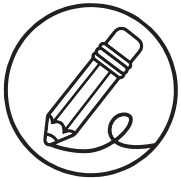

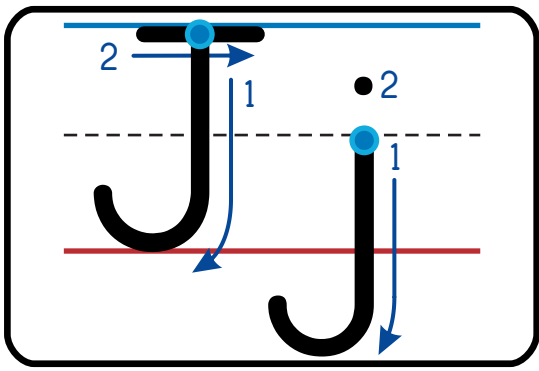

Name:

Letter Sort

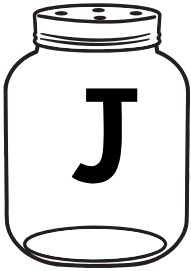
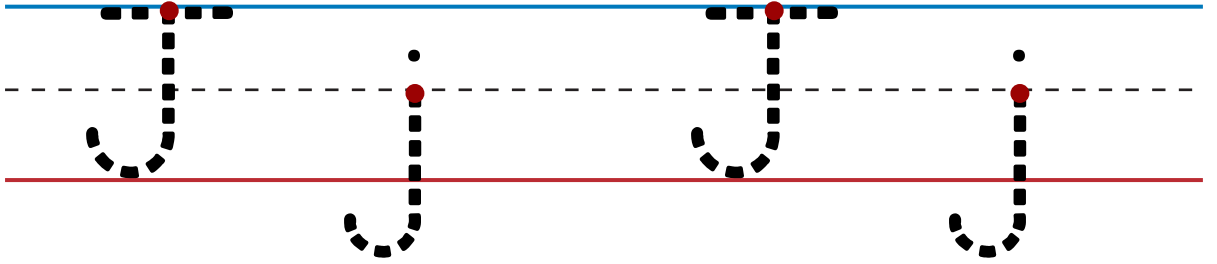
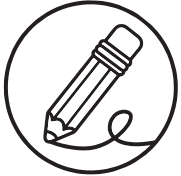

--	--	--	--

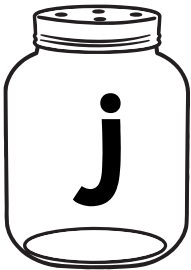

--	--	--	--

Letter of the Week by Lavinia Pop © 2013

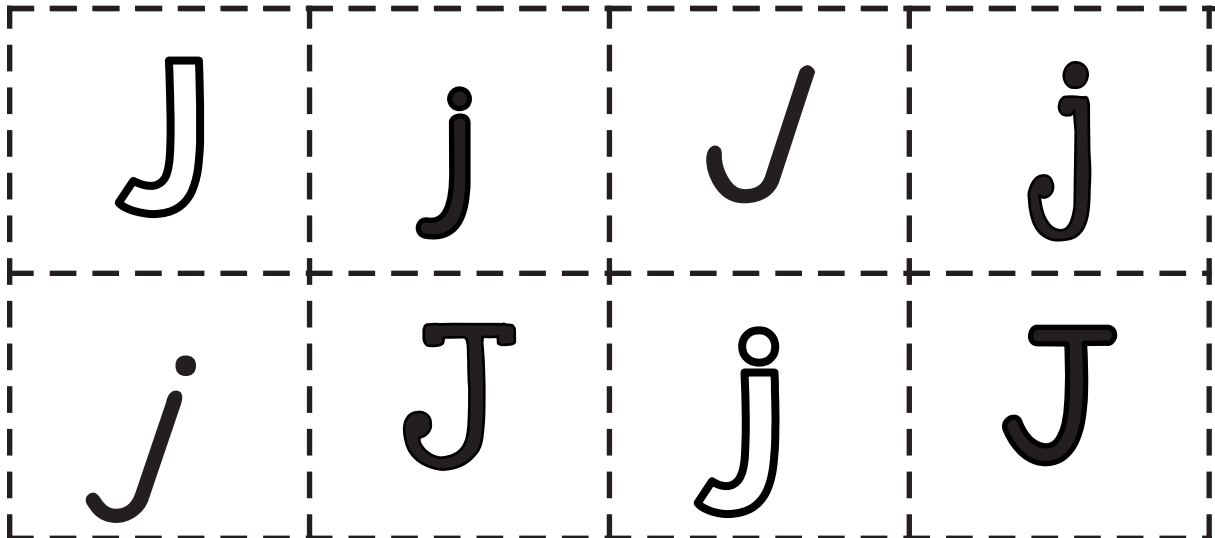
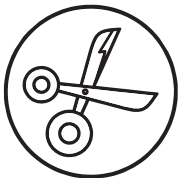

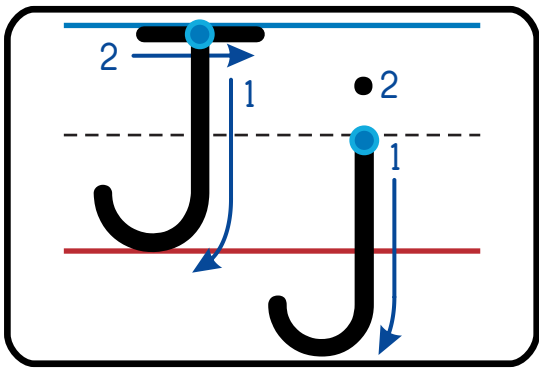

Name:

Letter Sort

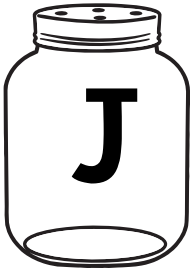
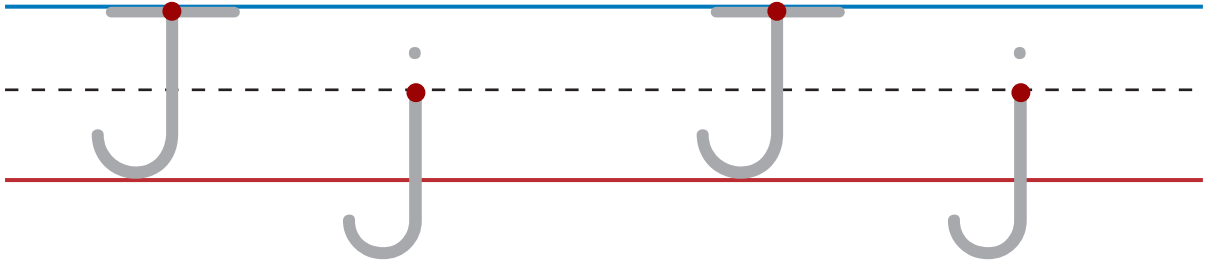
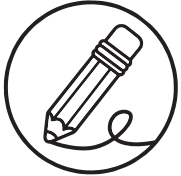

--	--	--	--

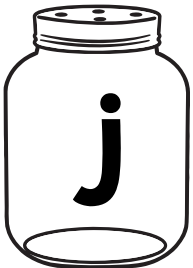

--	--	--	--

Letter of the Week by Lavinia Pop © 2013

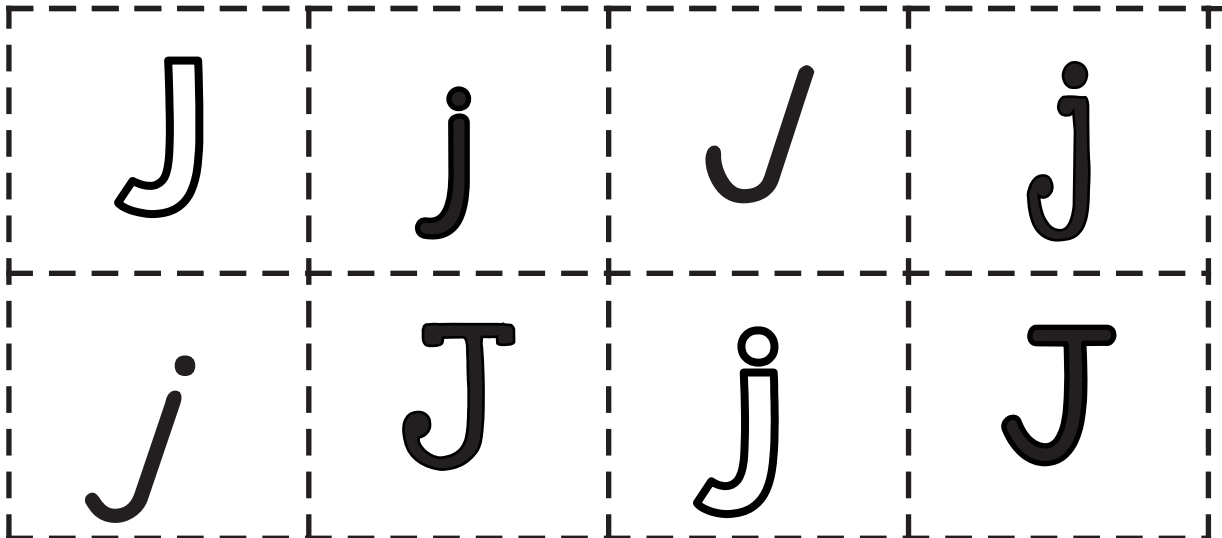
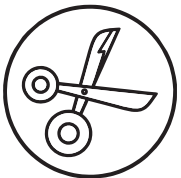

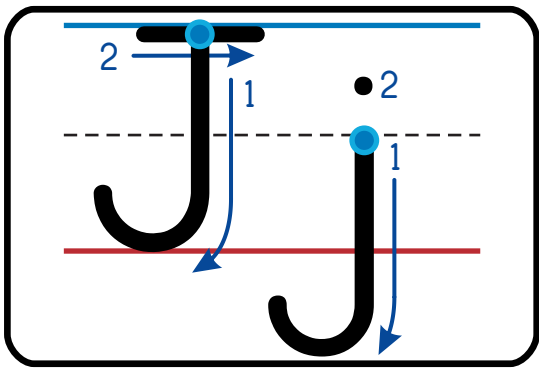

Name:

Beginning Sounds

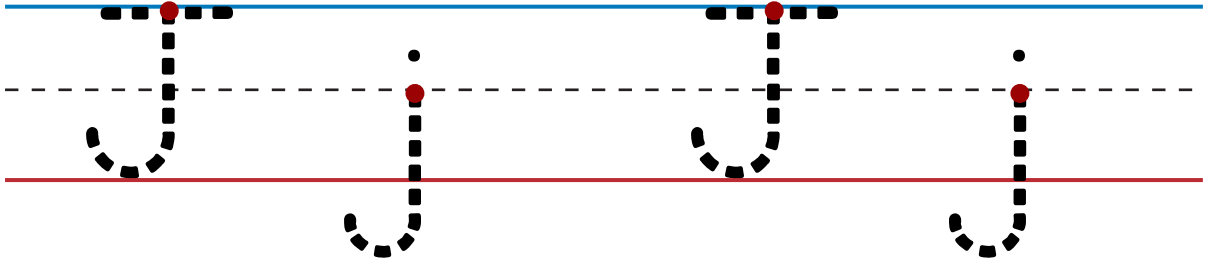
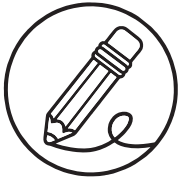

J

--	--	--	--

~~J~~

--	--	--	--

Letter of the Week by Lavinia Pop © 2013

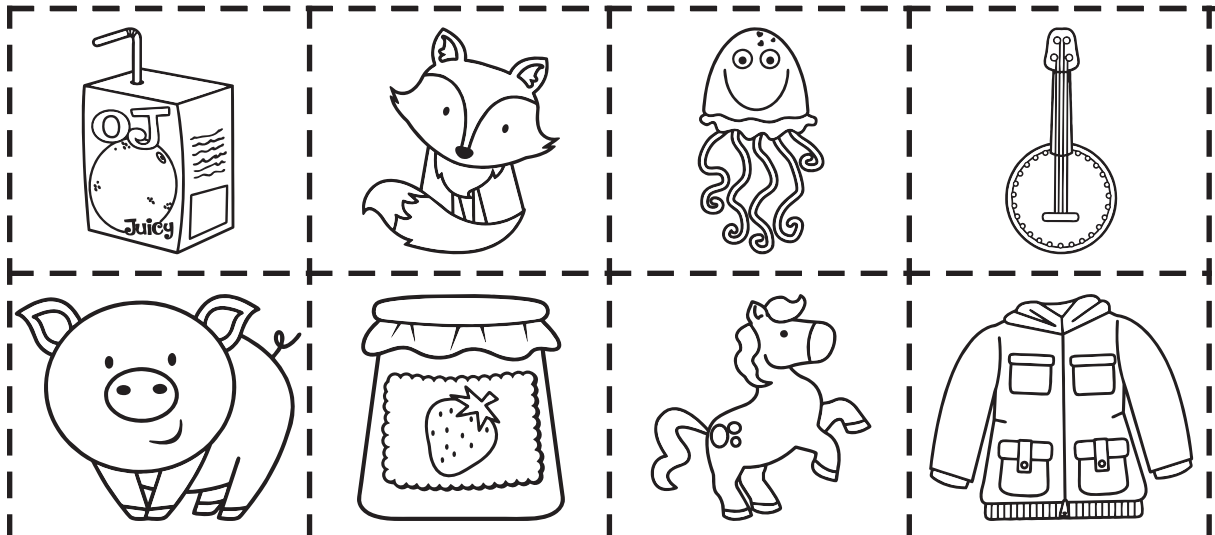
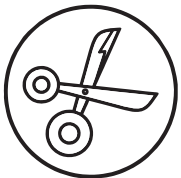

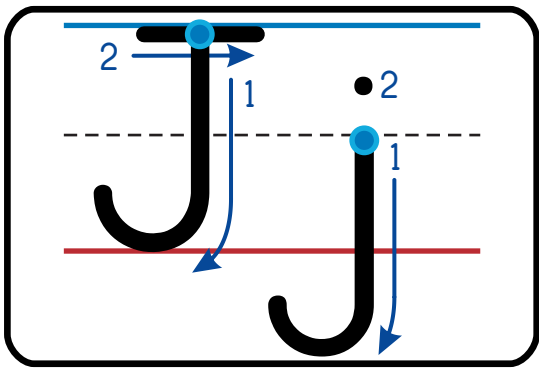

Name:

Beginning Sounds

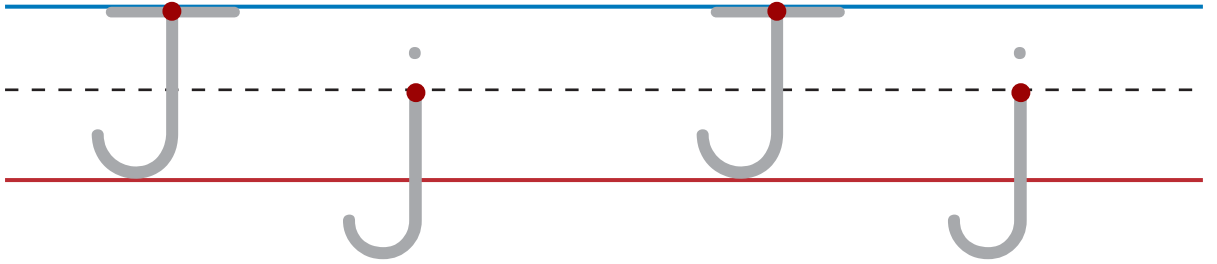
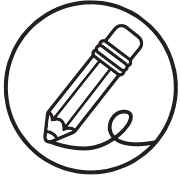

J

--	--	--	--

~~J~~

--	--	--	--

Letter of the Week by Lavinia Pop © 2013

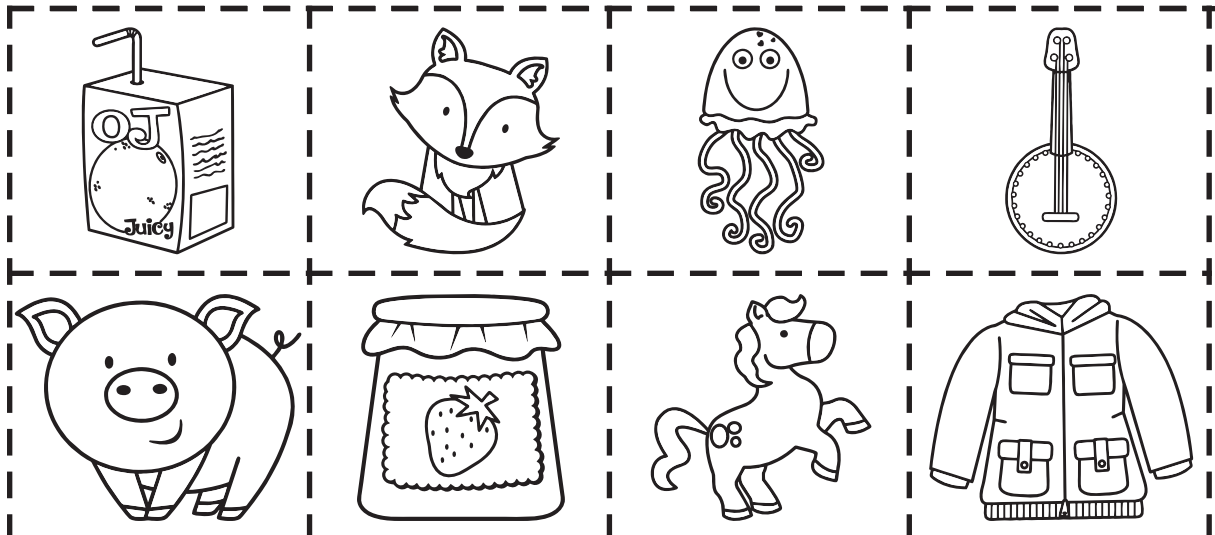
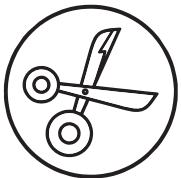

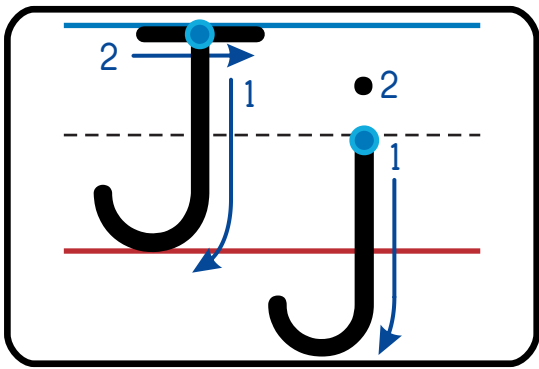

Name:

Word Match

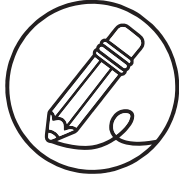

Trace



Glue

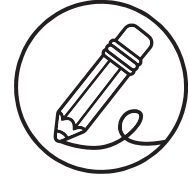

Write

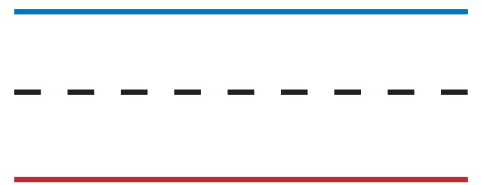
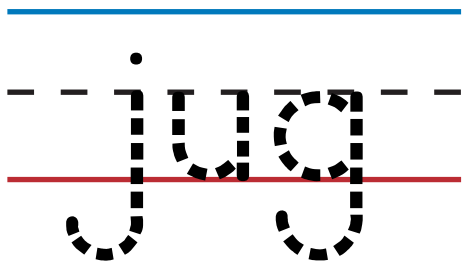
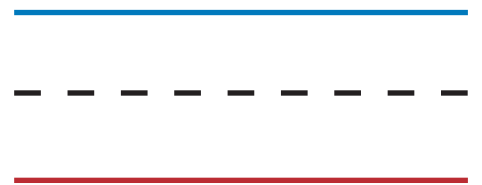
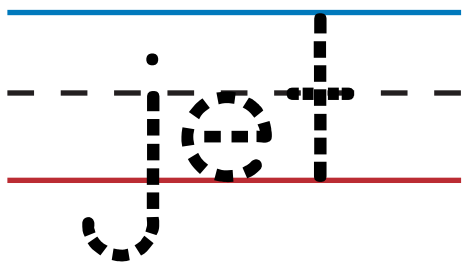
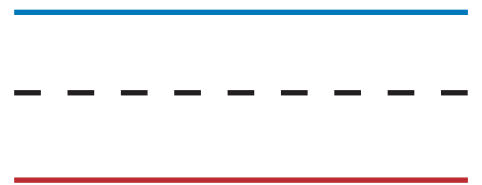
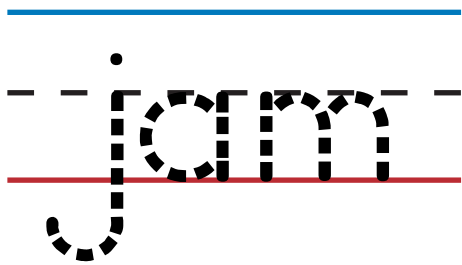

Letter of the Week by Lavinia Pop © 2013

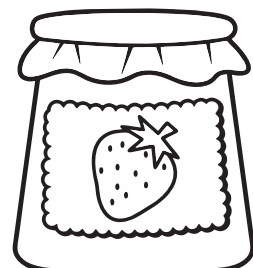
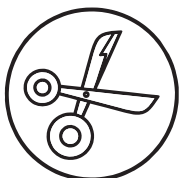

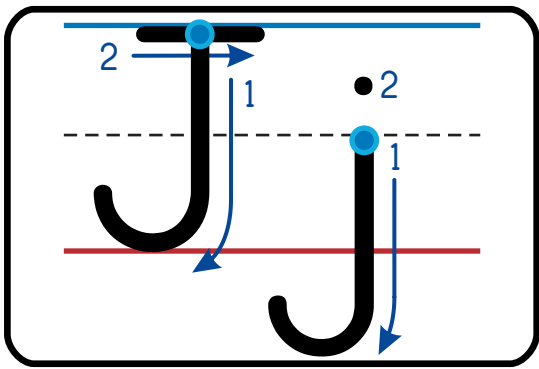

Name:

Word Match

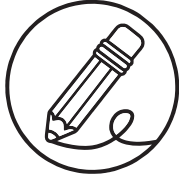

Trace



Glue

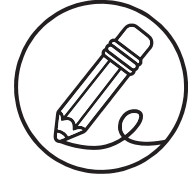

Write

jam



Blank handwriting lines for writing the word 'jam'.

jet

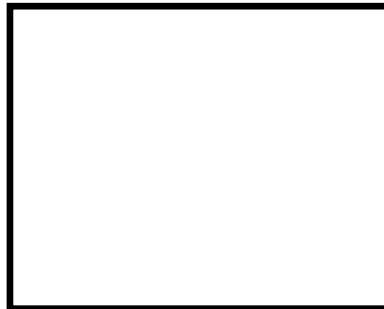

Blank handwriting lines for writing the word 'jet'.

jug



Blank handwriting lines for writing the word 'jug'.

Letter of the Week by Lavinia Pop © 2013

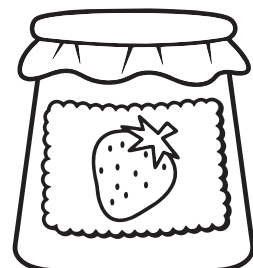
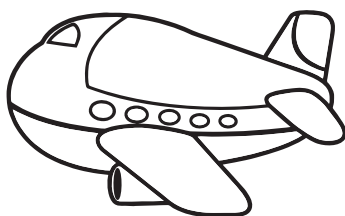
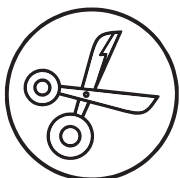

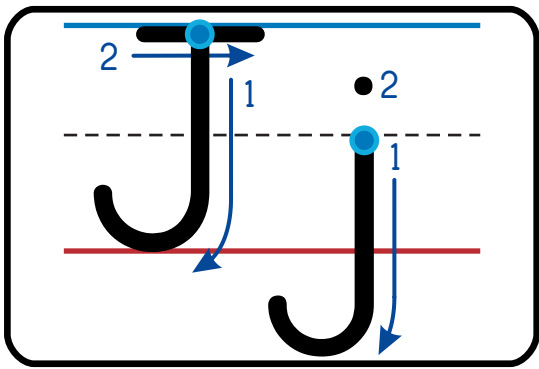

Name: _____

Read-Match-Write



Read the words below. Draw a line to match each word to the correct picture. Write the words in the matching boxes. Draw a line to match each picture to the correct box.

job

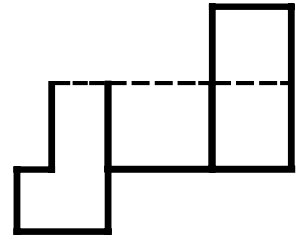

jam

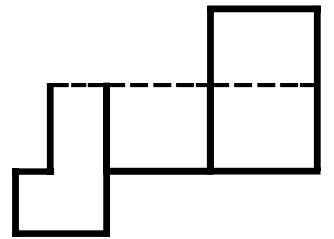

jig

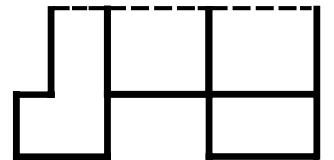
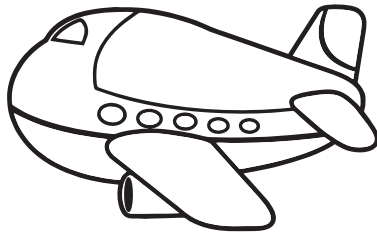

jab

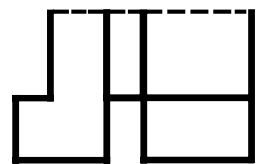
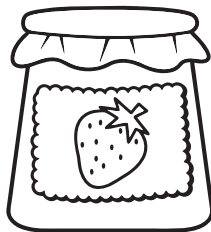

jug

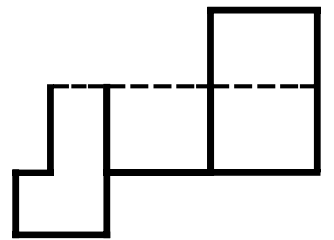

jet

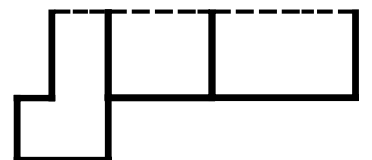

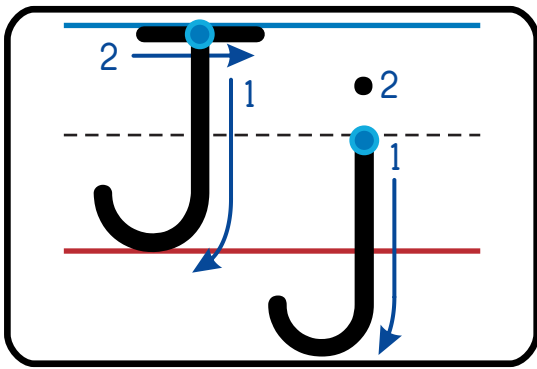

Name:

Homework



Color a jug each time you do this page.

- 1 Say the names for the following pictures. Circle the pictures if you hear the “Jj” sound. Is the sound at the beginning, middle or ending of the word?

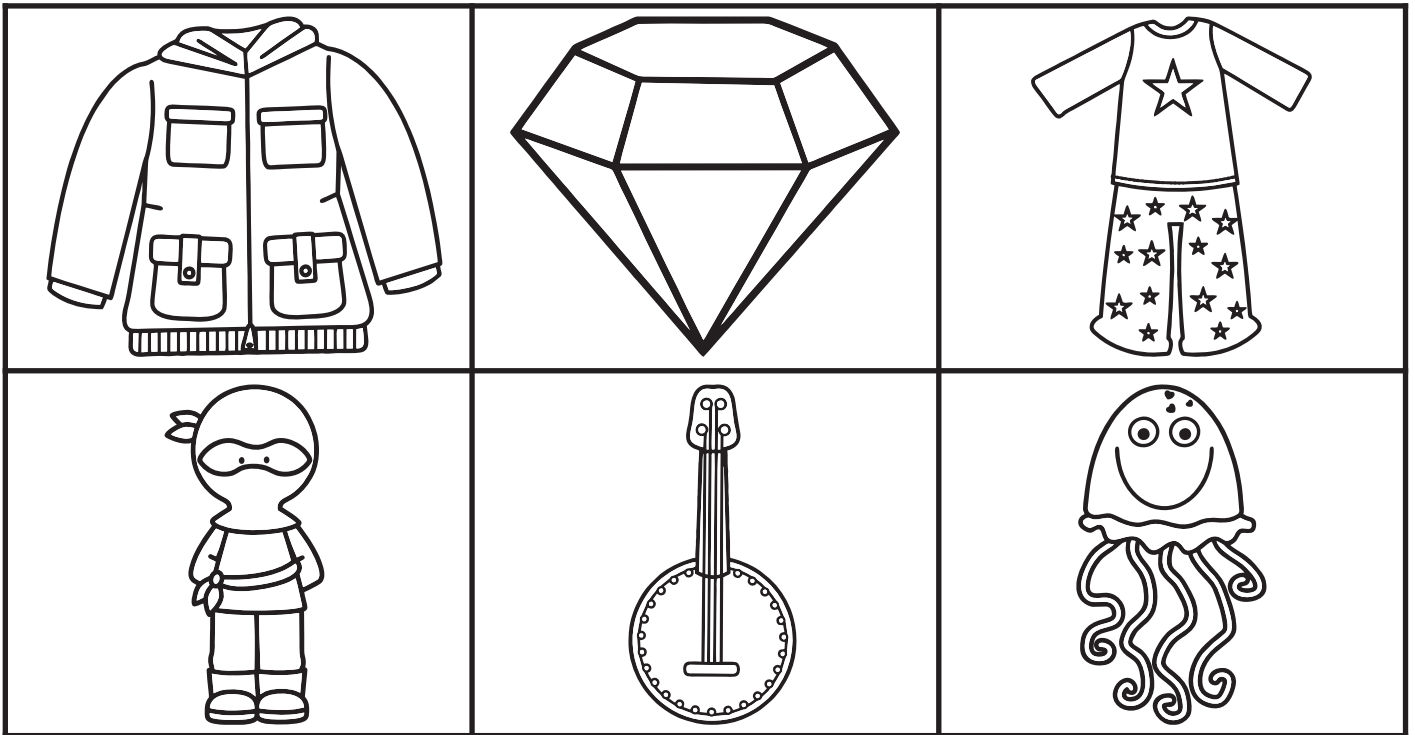

- 2 Think of other words that have the “Jj” sound.

- 3 Read the following words:

jam jet jig jog jump

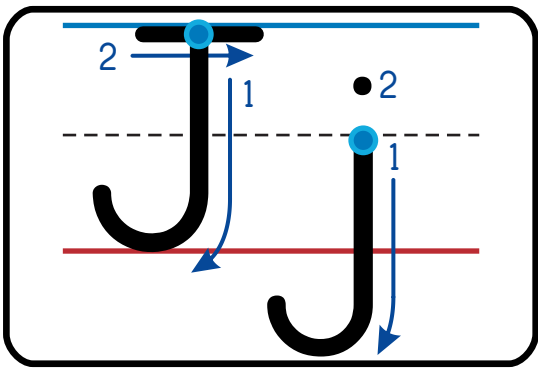

Name:

Reading Fluency



Color a jug each time you read all the sentences.

J is for jab.



J is for jam.



J is for jet.

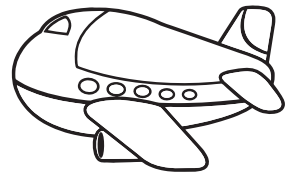

J is for jig.



J is for job.



J is for jug.



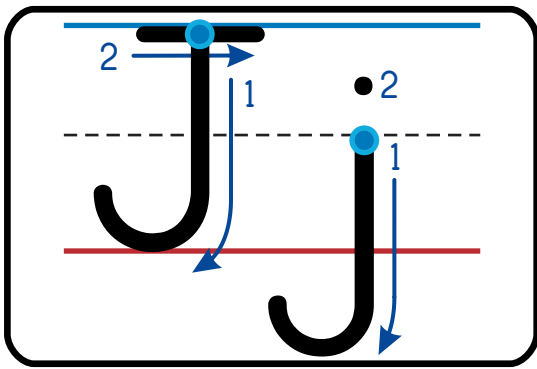

Name: _____

Reading



Read and trace the words. Underline j.

jug

jump

jar

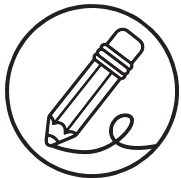
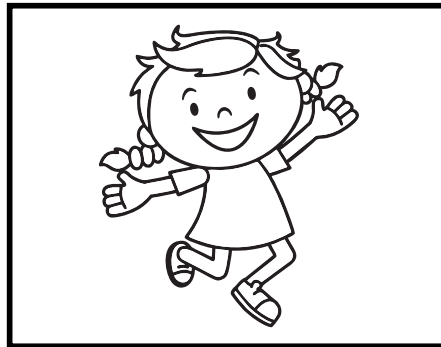

Underline J and j in the nursery rhyme.

**Jack and Jill went up the hill
To fetch a pail of water.
Jack fell down
And broke his crown,
And Jill came tumbling after.**

How many "Jj"s did you find? _____

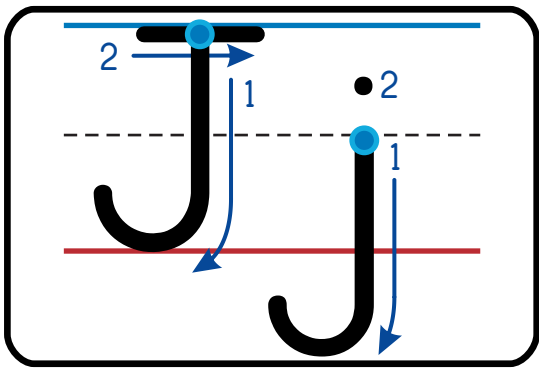

Name:

Build a Sentence



This is his jam.



--	--	--	--

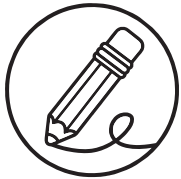

Blank handwriting lines for practice.

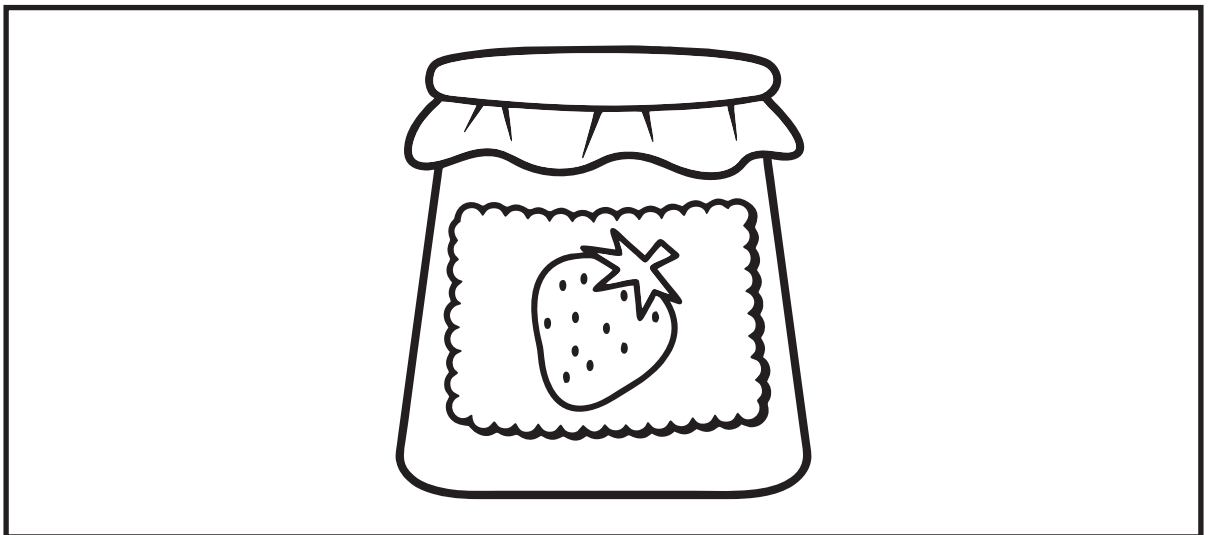
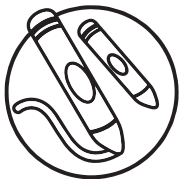

Letter of the Week by Lavinia Pop © 2013

his This jam. is

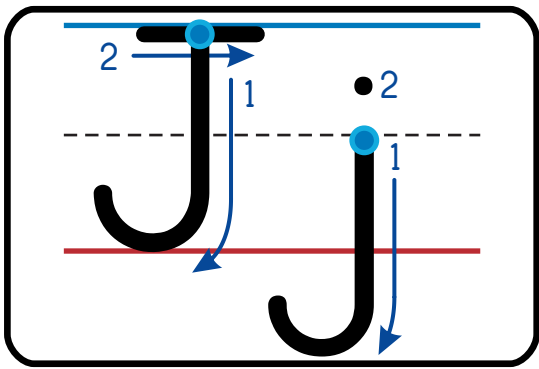

Name:

Build a Sentence



This is his jet.



--	--	--	--

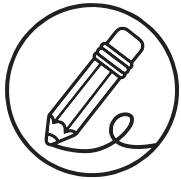

Blank handwriting lines for practice.

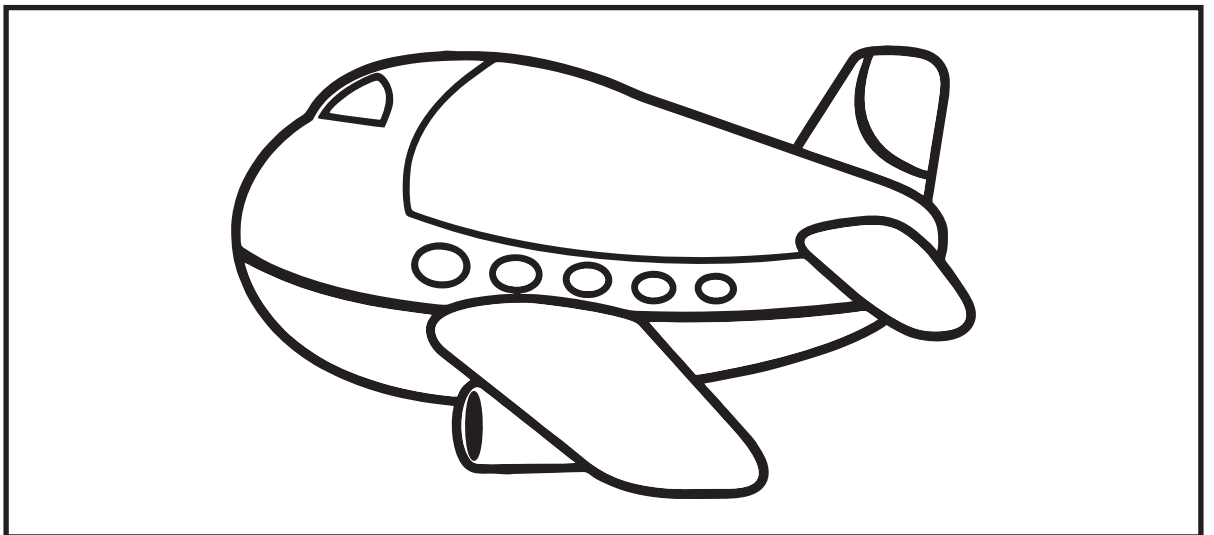
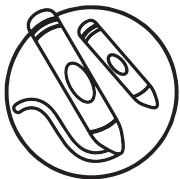

Letter of the Week by Lavinia Pop © 2013

jet. his is This

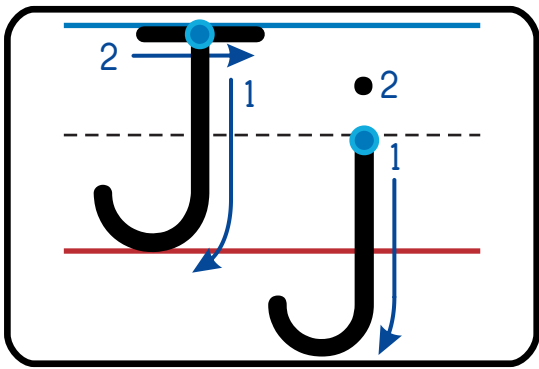

Name:

Build a Sentence



This is his job.



--	--	--	--

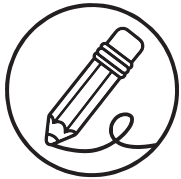

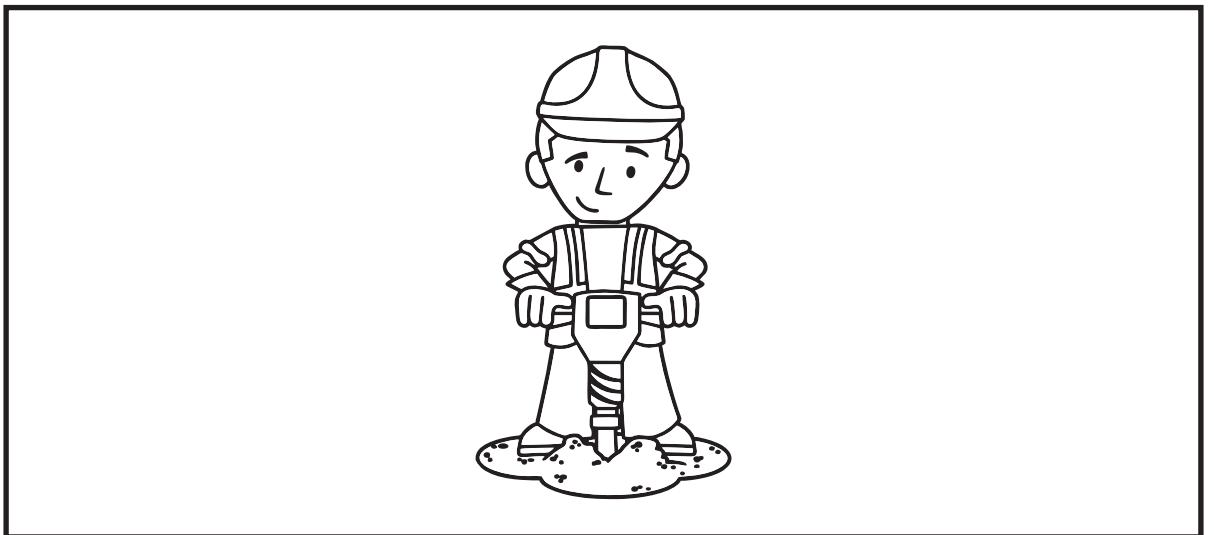

Letter of the Week by Lavinia Pop © 2013

job. his This is

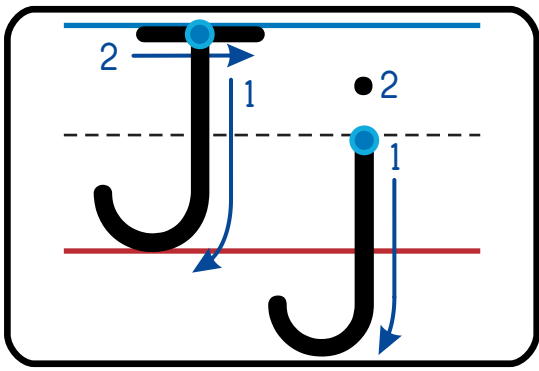

Name:

Build a Sentence



This is his jug.



--	--	--	--

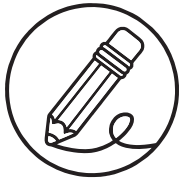

Blank handwriting lines for practice.

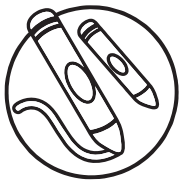

Letter of the Week by Lavinia Pop © 2013

his This jug. is

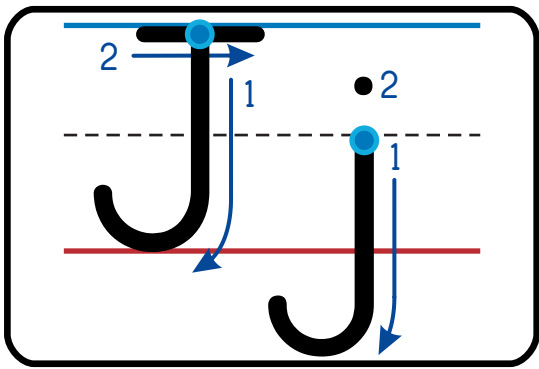

Name:

Build a Sentence



This is his jeep.



--	--	--	--

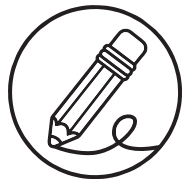

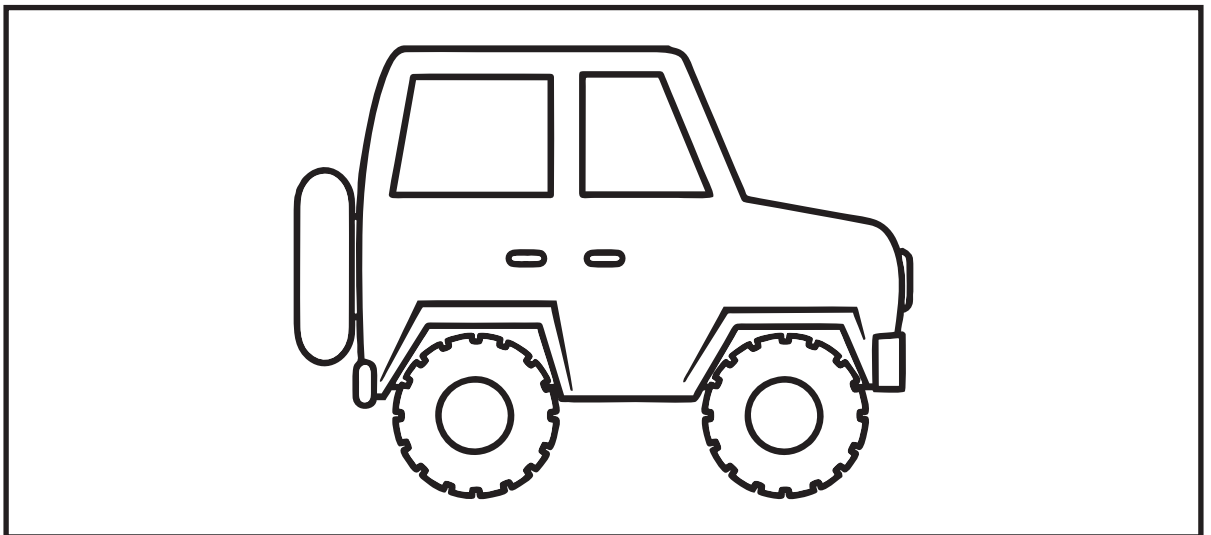

Letter of the Week by Lavinia Pop © 2013

jeep. his is This

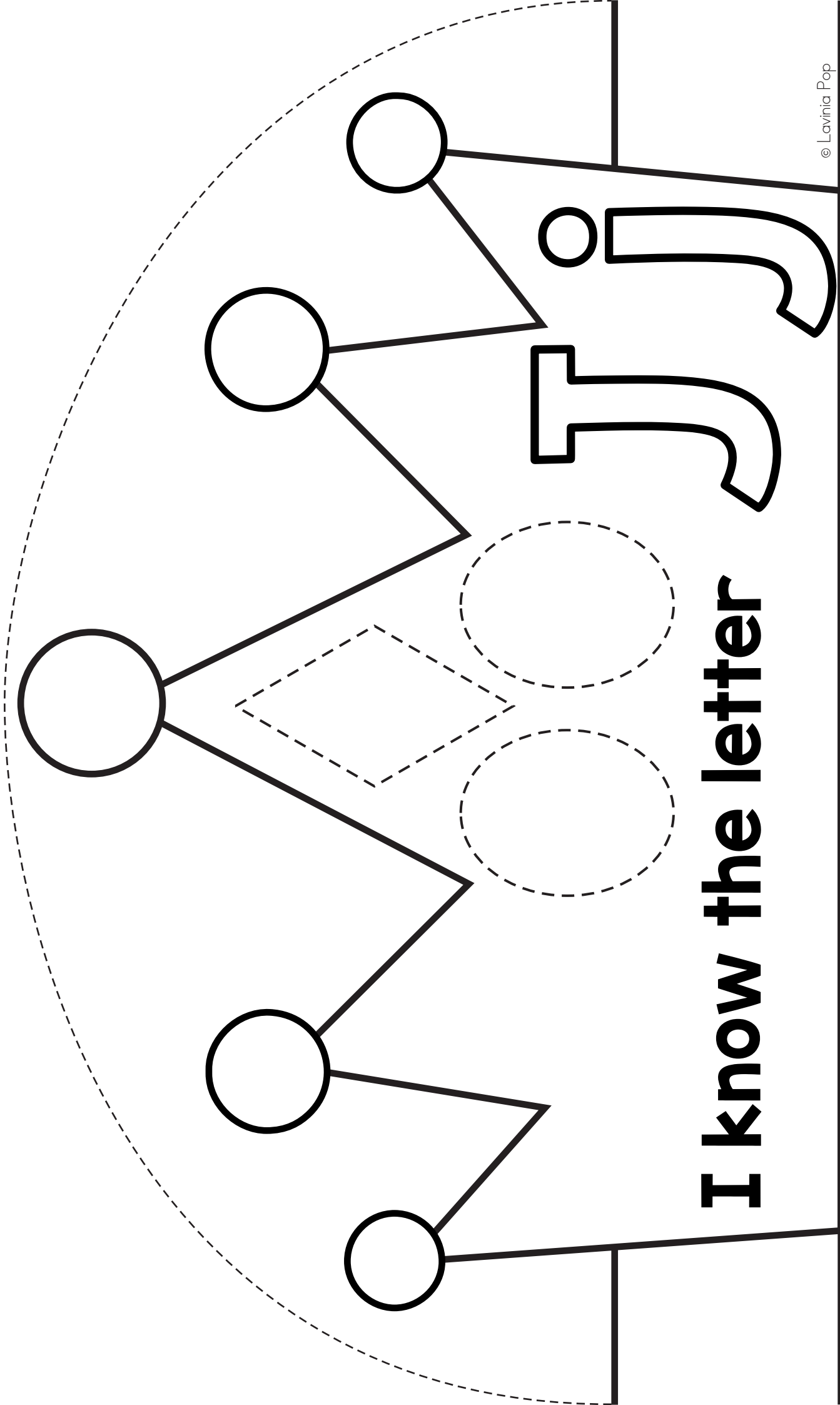

I know the letter

J j

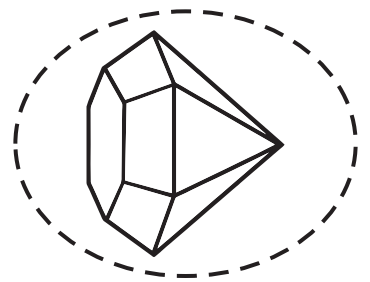
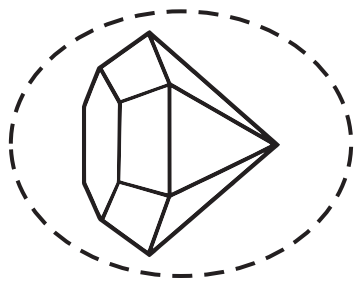
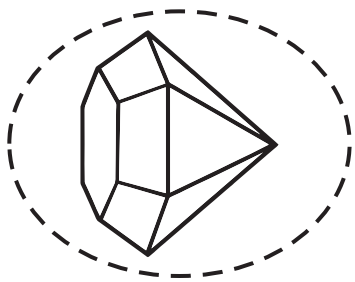
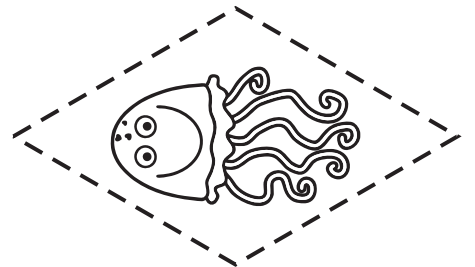
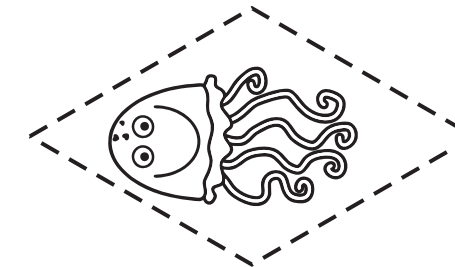
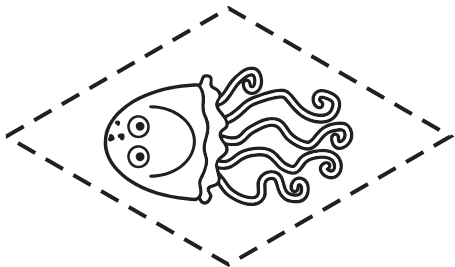
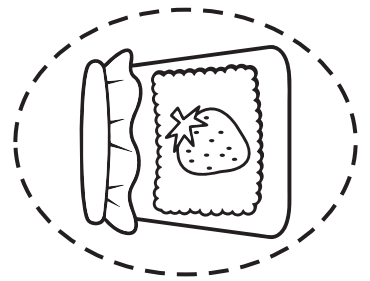
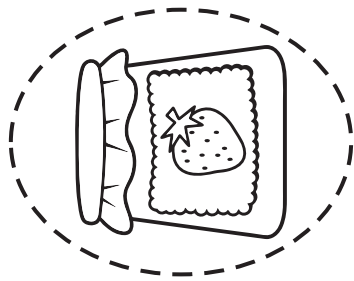
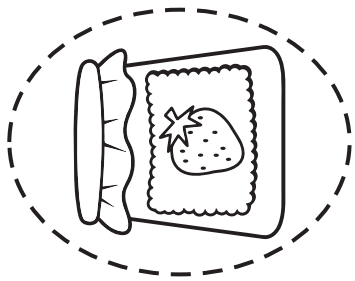
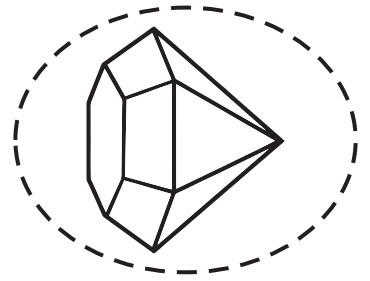
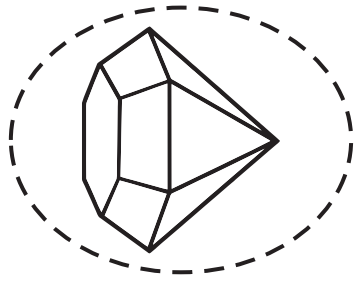
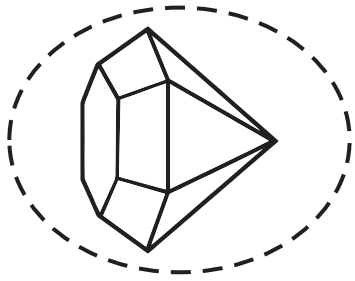
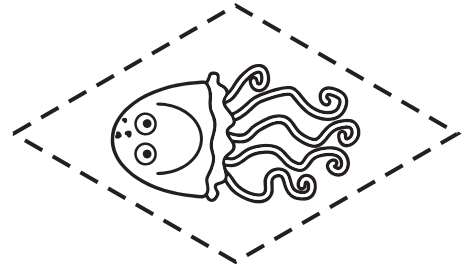
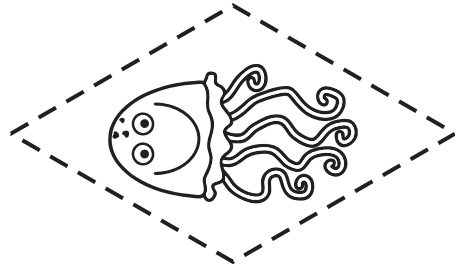
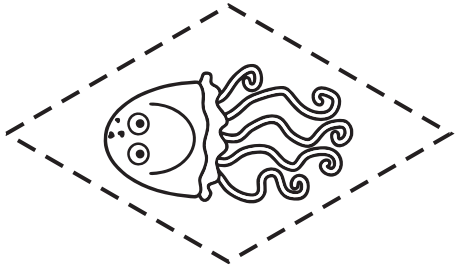
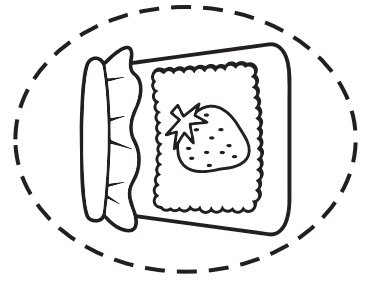
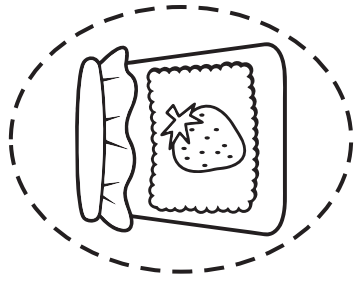
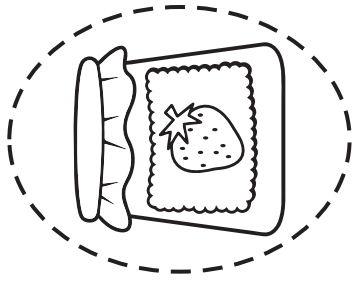

glue/staple

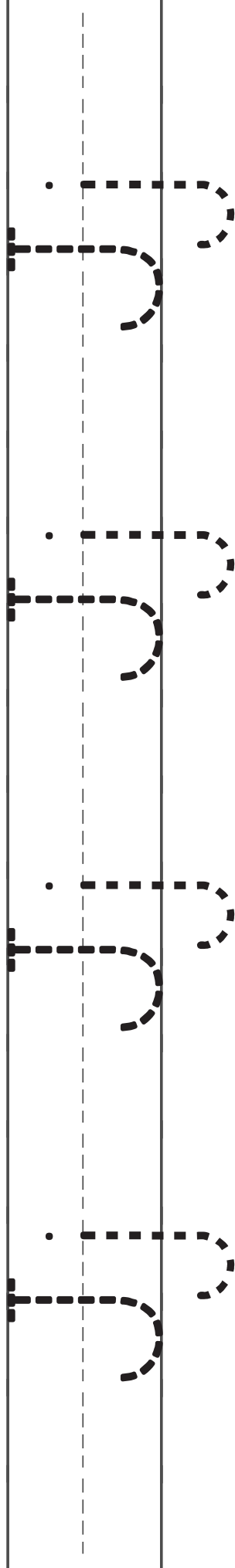

glue/staple

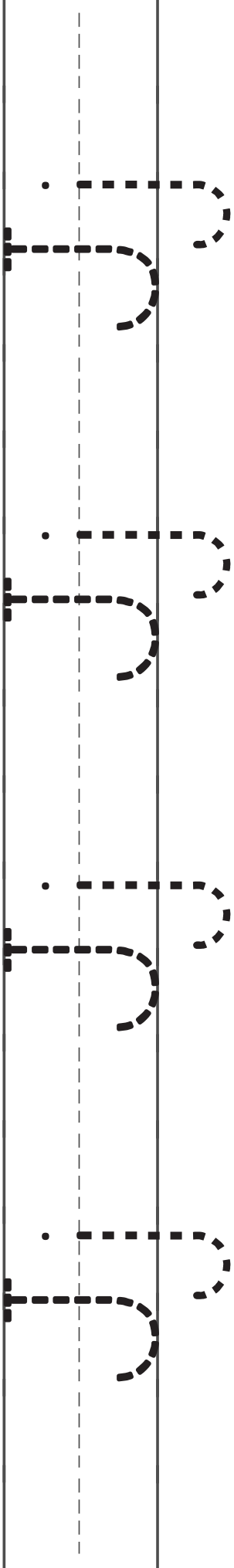

glue/staple

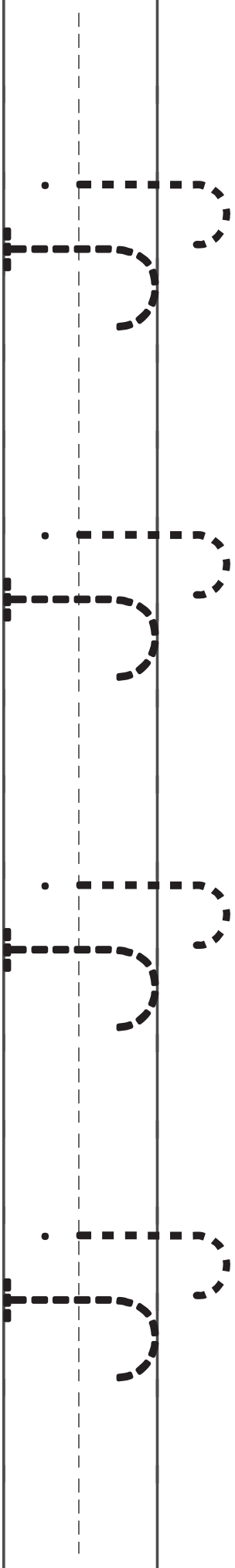

glue/staple

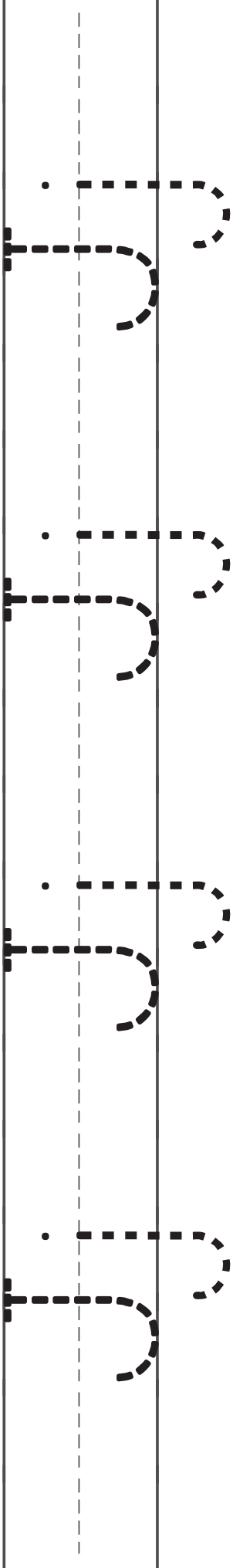

glue/staple

glue/staple

glue/staple

glue/staple

