

PHONICS

L E T T E R

of the

Week



Lavinia Pop

Thank you for downloading this product; I hope you will enjoy using it and that it will be a valuable resource for you! I value your feedback, so please don't hesitate to contact me if you have any concerns whatsoever as I will endeavour to address them. And if you like what I've done, please let me know by leaving feedback at my online store :)

Lavinia

lavinia@inmyworld.com.au

ILLUSTRATIONS Just So Scrappy 2, Pink Cat Studio, TeacherScrapbook, Little Red, Jessica Weible Illustrations, Dancing Crayon Designs, Blue Bees Workshop, Ramona Majdis, Kari Bolt, Whimsy Clips

www.justsoscrappytoo.com www.pinkcatstudio.com www.teacherspayteachers.com/Store/Teacherscrapbook
www.teacherspayteachers.com/Store/Littlered www.shop.jwillustrations.com www.dancingcrayon.com
www.teacherspayteachers.com/Store/Blue-Bees-Workshp www.teacherspayteachers.com/Store/Ramona-Majdis
www.teacherspayteachers.com/Store/Kari-Bolt www.teacherspayteachers.com/Store/Whimsy-Clips

FONTS www.schoolfonts.com.au www.teacherspayteachers.com/Store/Kimberly-Geswein-Fonts

PRINTING TIP This resource has been designed for printing on A4-sized paper. If you are printing on a different size, select “shrink to printable area” or “print to fit page” (or a similar option) in order for the contents of this unit to print correctly.

Copyright © 2013–2016 by Lavinia Pop – All rights reserved by author.

Purchase of this item entitles the purchaser the right to reproduce the pages for personal and classroom use. Duplication for other classes, an entire school or commercial purposes is strictly prohibited without written permission from the author. Minor editing is permitted only for personal use, however the document remains under copyright even when edited. Posting this item in whole or in part on the Internet in any form is strictly prohibited and is a violation of the Digital Millennium Copyright Act (DMCA). Please be fair and don't share! If you are not the original purchaser of this file, please visit my blog to obtain a link to one of my online stores. www.inmyworld.com.au

Click to connect...



www.inmyworld.com.au



www.facebook.com/inmyworldlaviniapop



www.pinterest.com/laviniapop

Contents

Introduction	4-8
Poster with correct letter formation	9
Poster with CVC words	10
Flash cards with correct letter formation	11
Play dough mat with correct letter formation	12
Write and wipe cards with correct letter formation	13
Write and wipe letter mat	14
Vocabulary cards	15-18
Doggie, Where's the Sound? game	19-24
Build-a-sentence center	25-26
Letter flip book	27-30
Activity mini-book	31
Alphabet reader	32-43
Missing letter cut and paste reader	44-51
Picture scramble cut and paste booklet	52-59
Letter maze	60
Font discrimination maze	61
Hidden letter worksheet (2 sets)	62-63
Beginning sounds colouring worksheet	64
Letter find	65
Handwriting practice	66-67
Upper and lower case cut and paste	68-69
Beginning sounds cut and paste	70-71
CVC words cut and paste	72-73
CVC word match	74
Letter identification worksheet	75
Build-a-sentence cut and paste worksheet (set of 5)	76-80
Homework reading sheet	81
Alphabet crown	82-84
Letter craft	85-86

Introduction

About this book:

This Phonics Letter of the Week unit has been designed to be used with children in Kindergarten (Prep). It contains a variety of games, activities and worksheets that will help teach correct letter formation, letter identification and recognition of letter sound.

The purpose of creating the Phonics Letter of the Week series, to which this unit belongs, was to provide a means by which one letter of the alphabet could be taught at a time. A great emphasis is placed on letter sounds, which makes this an ideal tool for teaching phonics.

Directions for use:

Before you begin...

Have the children say out loud the sound of the letter each time they work on a tracing worksheet; this will reinforce the relationship between the letter and the sound it makes. In addition to this, children will remember the sounds as they begin to read later on, and those that have trouble with reversals (such as the letters "b" and "d"), will remember that "b" starts at the top and "d" starts at the circle.

Following is an outline of what you will find in this book and suggestions for implementing the content in your classroom or home.

1. Poster with correct letter formation

To prepare the poster for use, print, laminate and display on your wall.

2. Poster with CVC words

This poster displays 10 CVC words that either begin with or contain the letter in focus. To set up, print laminate and display on your wall or include it in a file-folder word wall. (Please note: some vowel units do not contain CVC words or display 10 words).

3. Flash cards with correct letter formation

These cards display correct letter formation for both upper and lower case letters. They can be used as flash cards, tracing cards or even displayed as posters. To prepare the cards for use, print them out, laminate for durability and then cut them apart (optional).

4. Play dough mat with correct letter formation

Children will have lots of fun using play dough to reproduce the letters on the mat! They will learn correct letter formation and build up their fine motor skills in preparation for writing. To set up, print and laminate. (Cut in half if you want separate cards).

5. Write and wipe cards with correct letter formation

Children can practice correct letter formation over and over with these cards using a dry-erase (whiteboard) marker. To prepare the cards for use, print, laminate and cut out. To keep the cards together, make a hole in the top left hand corner and secure with a key ring or pipe cleaner.

6. Write and wipe letter mat

This mat has been designed for use in a Write and Wipe center with a dry-erase (whiteboard) marker. Children trace both upper and lower case letters, a word that begins with the focus letter and 5 CVC words that begin with or contain the focus letter. To prepare, print and laminate.

7. Vocabulary cards

This set contains 18 vocabulary cards that begin with the focus letter and 9 cards that contain or end with focus letter. These can be used as:

- vocabulary flash cards
- a matching card game (for which you will need to print 2 sets)

To prepare for use, print, laminate and cut the cards apart.

I have also included a Write the Room activity worksheet. Children write down as many words that begin with the focus letter that they can see in the room.

8. Sound Hound center activity

Set-Up: Print, laminate and cut out the dog you prefer to use and the picture cards. Cut the dog down the dotted lines to separate the head, middle and tail sections.

Each card displays a picture with the focus letter above it. The aim is for children to identify the position of the letter (beginning/head; middle/tummy or end/tail) as they say each word, and place the cards under the corresponding dog section. They then complete the accompanying worksheet. (The worksheet can also be used independently of the center activity).

9. Build-a-sentence

Set-Up: Print the contents of this page and laminate it for durability. Cut out the sentence base (entire first row) and along the dotted lines of the picture cards to obtain 8 squares. You may store these in a large zip-lock bag.

The aim of this game is to practice reading a predictable sentence using different vocabulary words that begin with the focus letter. Children choose a picture card from the pile and place it over the coloured square on the sentence frame, then read the sentence out loud. I have included a recording sheet children to complete once they finish the activity.

10. Alphabet flip book

Set-Up: Assembly is required, either by teacher or students. You will need to cut around each rectangle box, then along the dashed lines of the bottom one. Make sure that the top rectangle is left intact as it will form the base for the flip book! Arrange the word cards one on top of the other and staple them to the base. Students will have lots of fun reading their books over and over again to friends and family! I have included a couple of recording sheets for this activity.

11. Activity mini book

A foldable mini-book with different activities: letter identification, beginning sounds and letter tracing. Simply fold the page vertically, down the middle, and then horizontally to create the book.

12. Alphabet reader

Set-Up: I have included 2 versions of this activity: black and white and coloured. Once you have selected your preferred version, print, then either teacher or student will need to cut each page in half and staple on the left hand margin to form a book. Children practice reading a predictable sentence that uses the most common sight words and simple words (mostly CVC) that begin with the focus letter.

13. Missing letter cut and paste reader

Set-Up: Once printed, place each page on top of each other in order, cut in half and staple to make 2 booklets. Also cut the last page so that you will get 3 strips of 6 letter pairs. Children are required to cut the 6 pairs apart and paste one on each page of their booklet, and then read the sentence on the page.

14. Picture scramble cut and paste booklet

Set-Up: Print the pages, stack them on top of each other and cut in half to form 2 booklets. Staple each one. Print the end scrambled picture tiles and leave it as is – children will cut these tiles apart and used them to build the words inside their booklets. Once all the words have been built, the right hand column on each page may be completed by colouring the word, tracing it, then writing it.

15. Letter maze

Children complete this worksheet by colouring the squares that contain the focus upper and lower case letters. The aim is to make a pathway from one end of the maze to the other.

16. Font discrimination maze

Children complete this worksheet by colouring the circles that contain the letter in focus. The aim is to help children recognise the focus letter written in different fonts.

17. Hidden letter worksheet (2 pages)

Children reveal the hidden letter by colouring each section using the colours indicated at the top of the page.

18. Beginning sounds colouring worksheet

Children colour the pictures that begin with the focus sound.

19. Letter Find

Children search for both upper and lower case letters, then write the number of times each one was found in the circles on the left hand side.

20. Handwriting practice (dotted and continuous line version included)

Children practice writing both upper and lower case letters.

21. Upper and lower letter sort (dotted and continuous line version included)

The main focus of this worksheet is on lower and upper case letter identification. Children trace the letters then cut out the letter from the bottom of the page and paste them in the correct column to show which ones are upper case and those that are lower case.

22. Beginning sounds cut and paste (dotted and continuous line version included)

Children begin this worksheet by tracing the upper and lower case letters at the top of the page and then cut out the pictures from the bottom of the page and paste them in the correct column to show whether they begin or don't begin with the focus sound.

23. Word match cut and paste (dotted and continuous line version included)

Children read the words in the left hand column and then trace them. To demonstrate comprehension, they are asked to cut the pictures from the bottom of the page and paste them next to the matching word. Finally, they write the words in the right hand column.

24. CVC read-match-write

Children read the words in the left column and then draw a line to match them to the correct pictures in the middle. Next, children write the words in the boxes on the right side of the page and then draw lines to match them to the pictures too.

25. Homework reading page

This homework sheet focuses on letter sounds. Children are asked to say the names for each of the pictures on the page and identify the position of the sound. Next, they think of other words that contain the focus sound and then they read a 5 CVC words.

26. Alphabet reading strips with CVC words (excluding vowel letters)

Children read the sentences on the page using the predictable pattern: "... is for..." Picture cues are given for each vocabulary word.

27. Reading page

Children trace the words at the top of the page and then underline the focus lower case letter in each one. Next, they underline or highlight the upper and lower case letters in the nursery rhyme at the bottom of the page and then then write how many focus letters were found.

28. Build-a-sentence cut and paste worksheets (set of 5)

Children begin this worksheet by reading a simple sentence, cutting and pasting the words from the bottom of the page in correct order to form the sentence, writing the sentence and then colouring a picture. (Please note: this set contains the same wording as in the reader.)

29. Alphabet crown

The crown can be completed at the end of the week as an “I know the letter!” achievement activity. Children cut out their crowns on the cutting line or around the solid shape. They also cut out the shapes containing 3 pictures and glue them onto their crowns. I have also included letter tracing head wraps that can be secured to each side of the crown to form the back part of it. Usage of this is optional; students could use string instead to tie to the crown so it will sit on their heads.

30. Alphabet craft

These two pages contain blank upper and lower case letter templates that you can use with children to create letter activities and crafts. Please visit my blog for craft ideas:

www.inmyworld.com.au/category/preschool

Happy Teaching :)

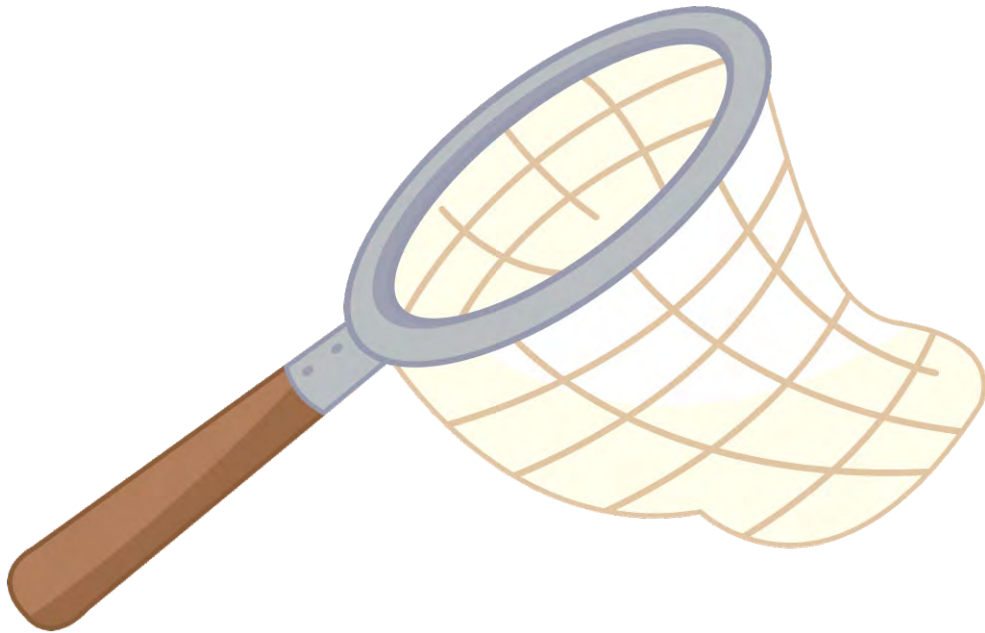
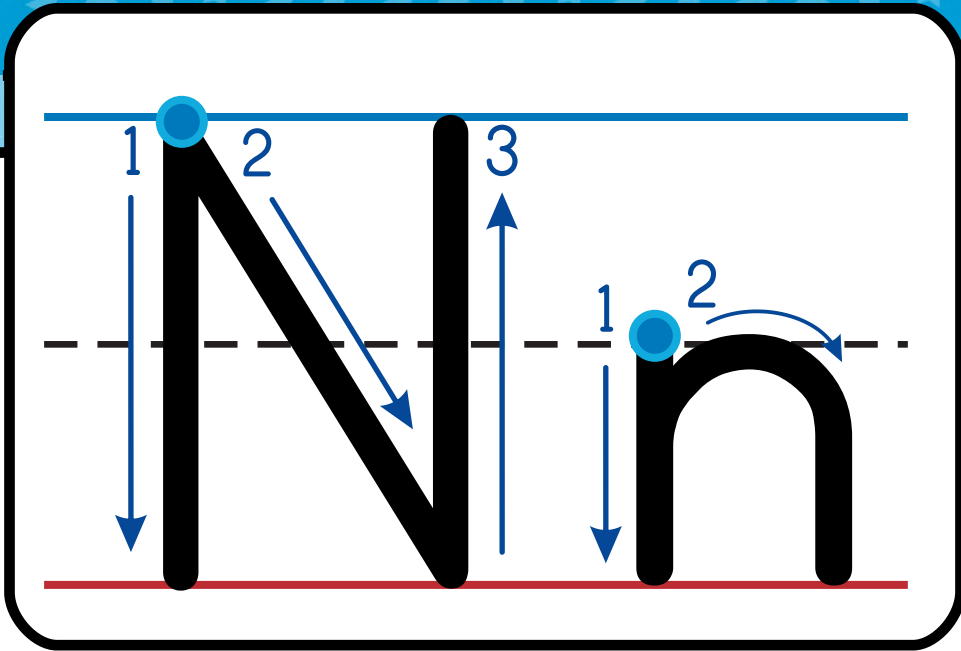

net

Nn

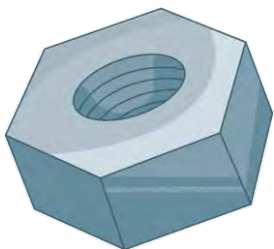

nag

nap

net

nip

nit

nod

not

nun

nut

nest

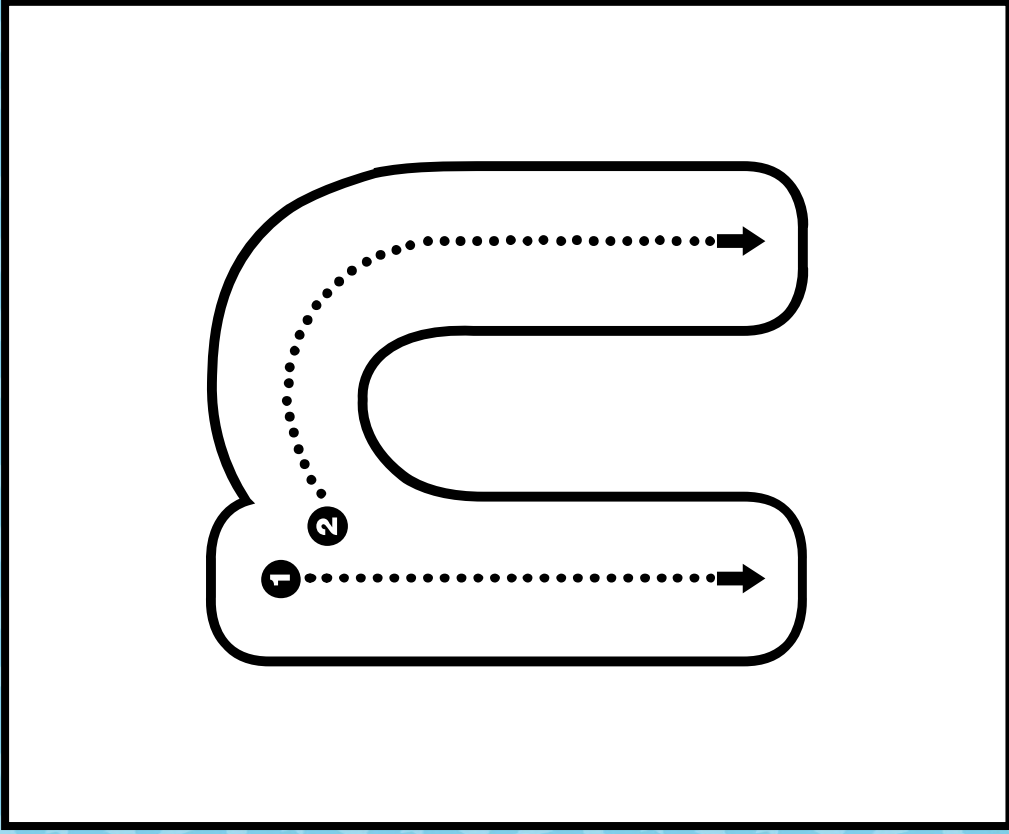

Lavinia Pop © 2013



net

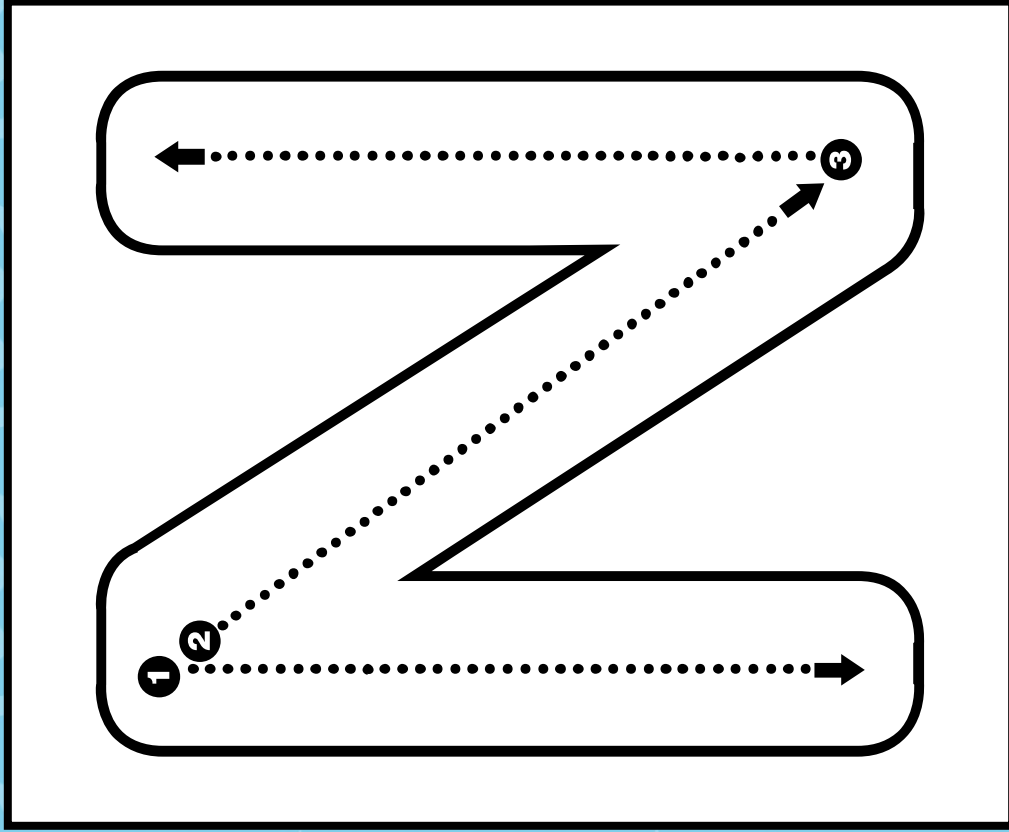

Lavinia Pop © 2013



Ned

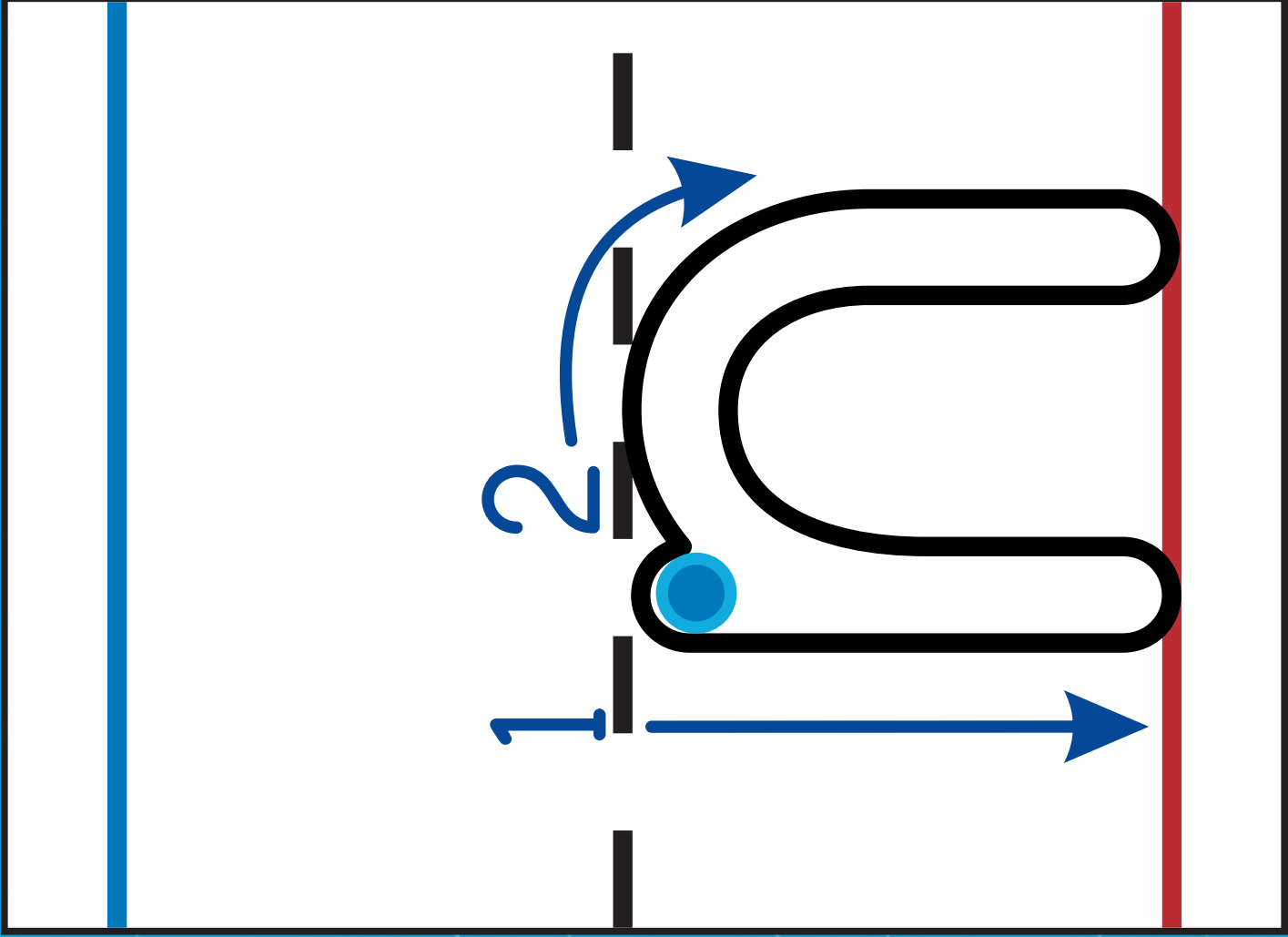
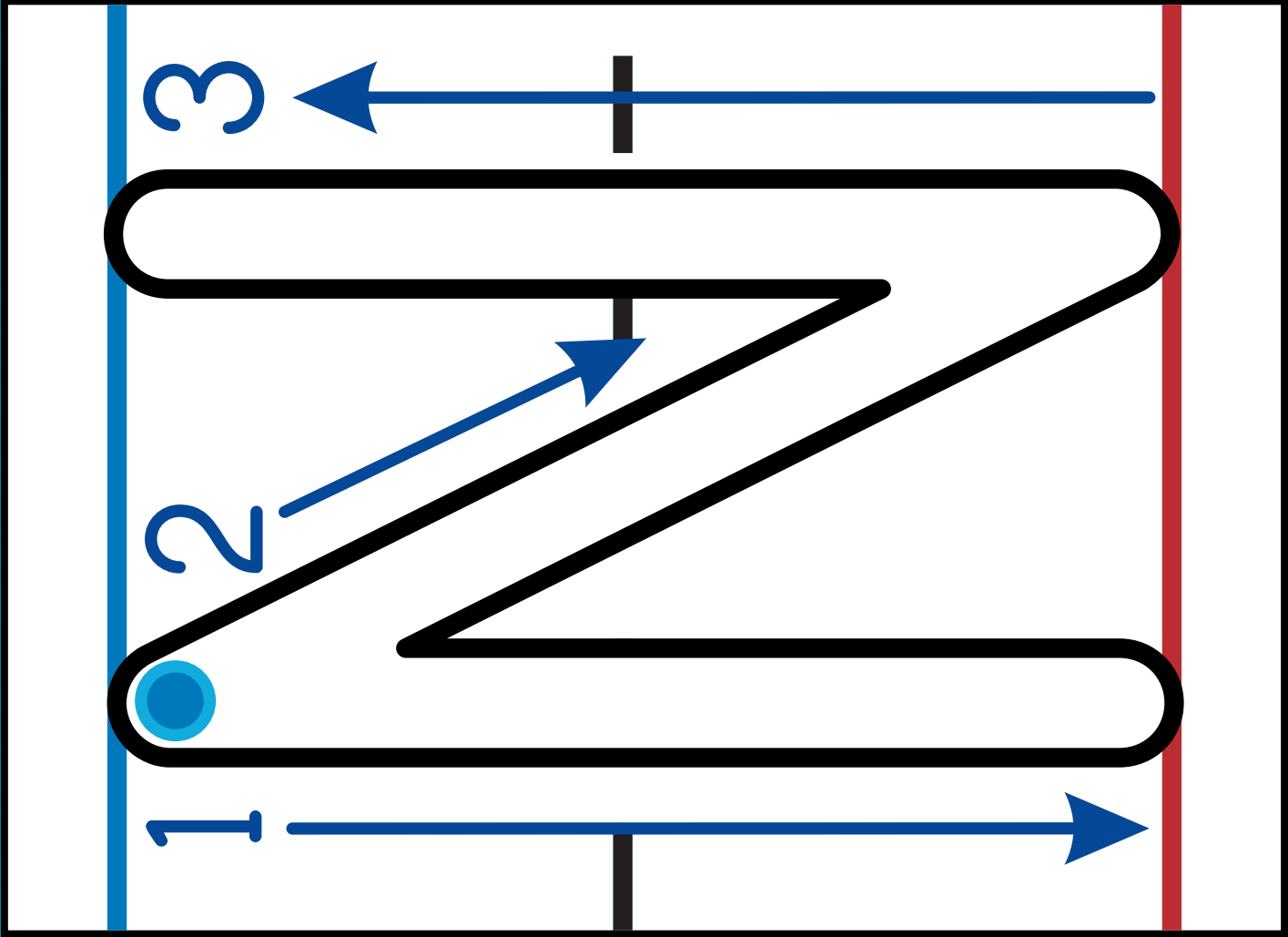

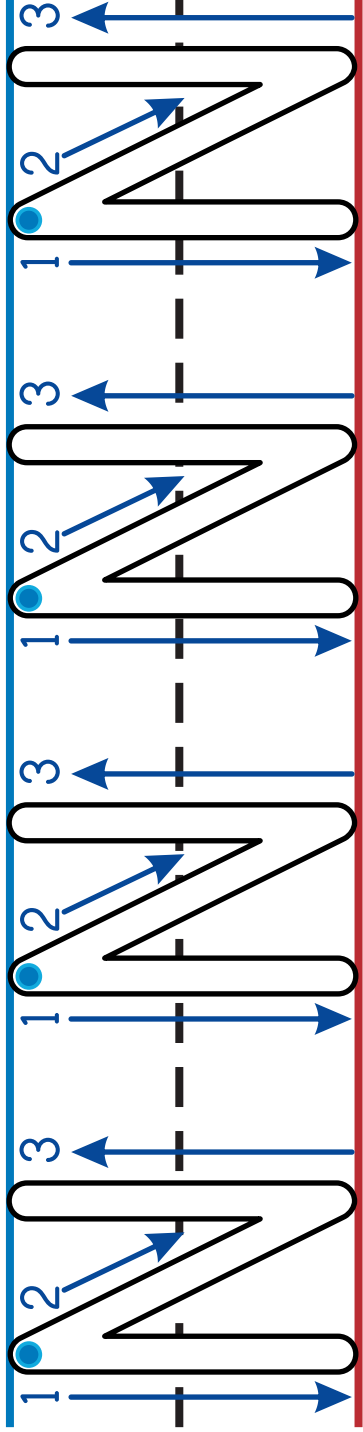

Lavinia Pop © 2013

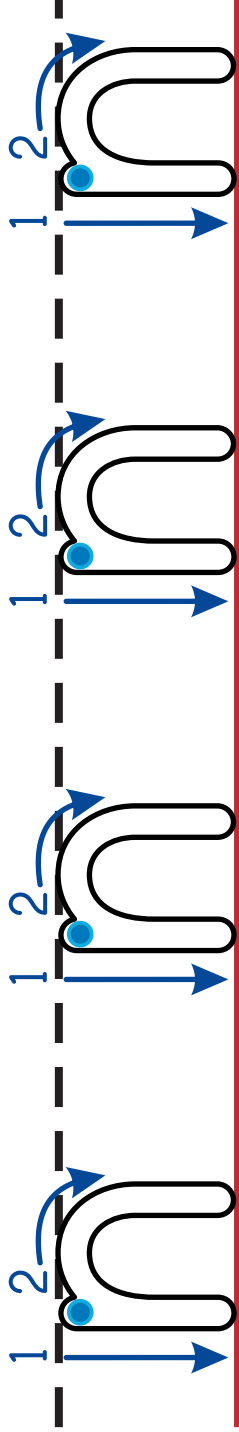
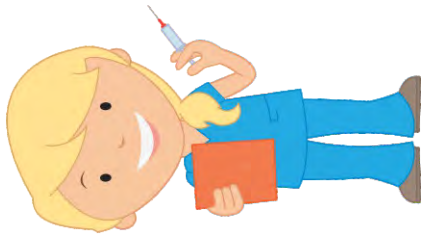

Lavinia Pop © 2013

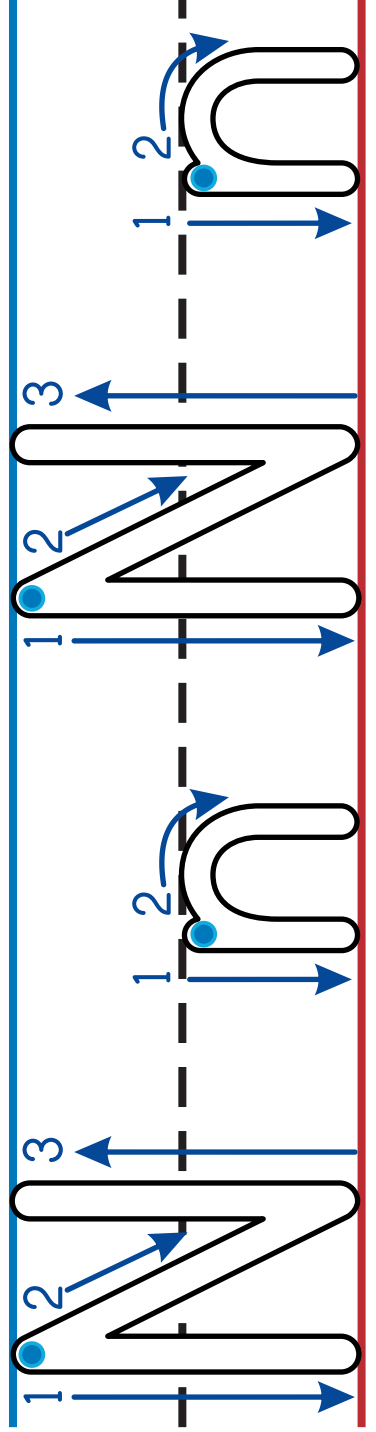
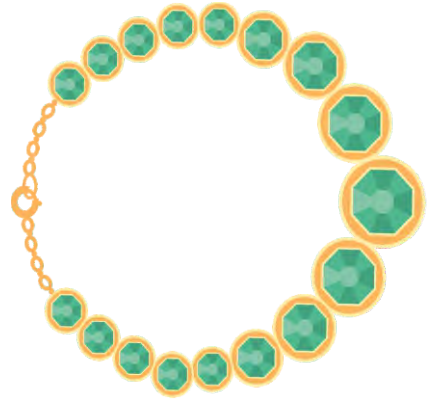

Lavinia Pop © 2013

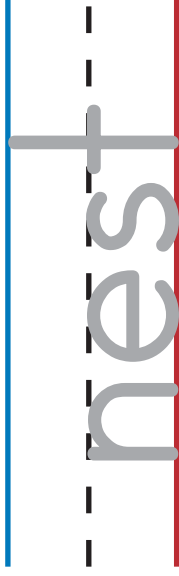
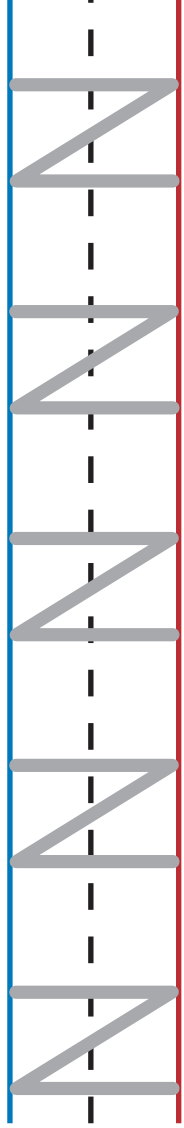
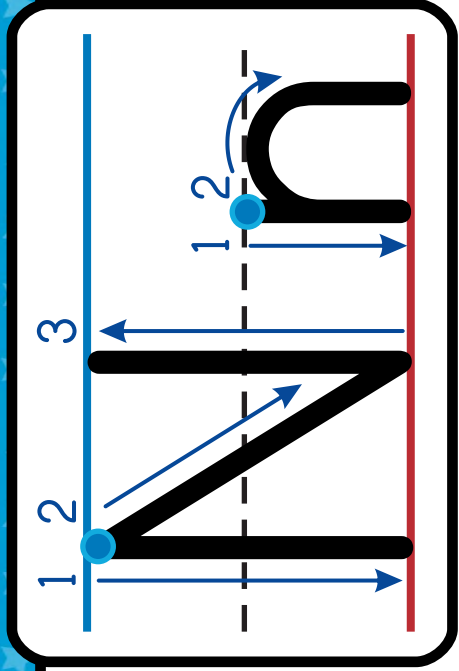

nap

net

nit

nod

nut

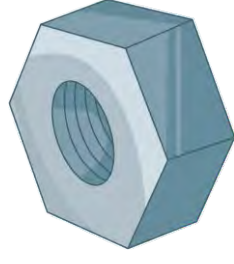
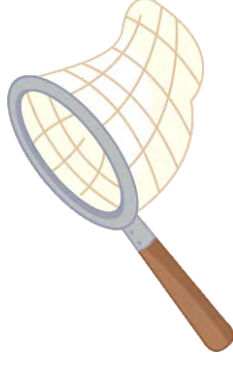

nag



nap



net



nit



nip



nod



nut

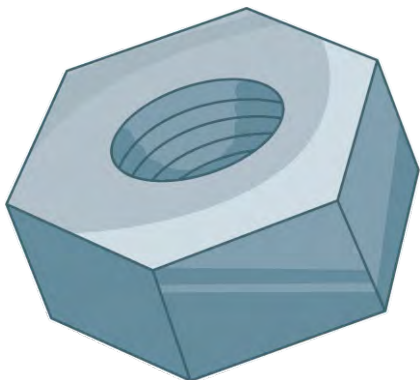

nest



note



newspaper



nurse



necklace



narwhal



nail



nose



needle

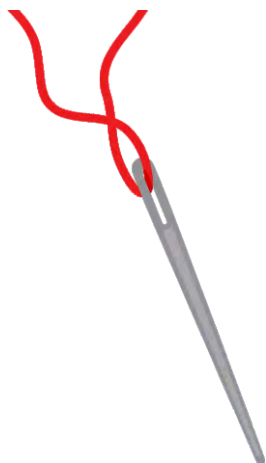

night



nine



pencil



money



magnet



dinosaur

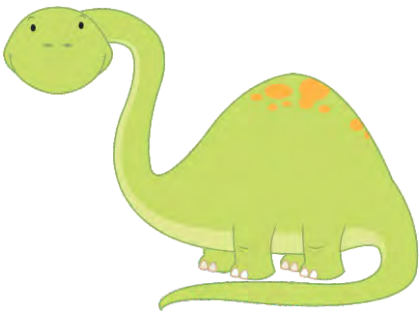

volcano



queen



wagon



van



moon



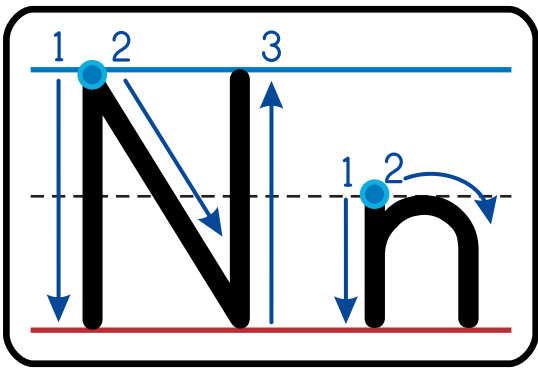

Name:

Write the Room

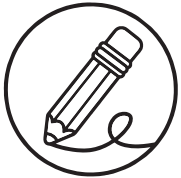

These are the words I found:

1 _____

6 _____

2 _____

7 _____

3 _____

8 _____

4 _____

9 _____

5 _____

10 _____

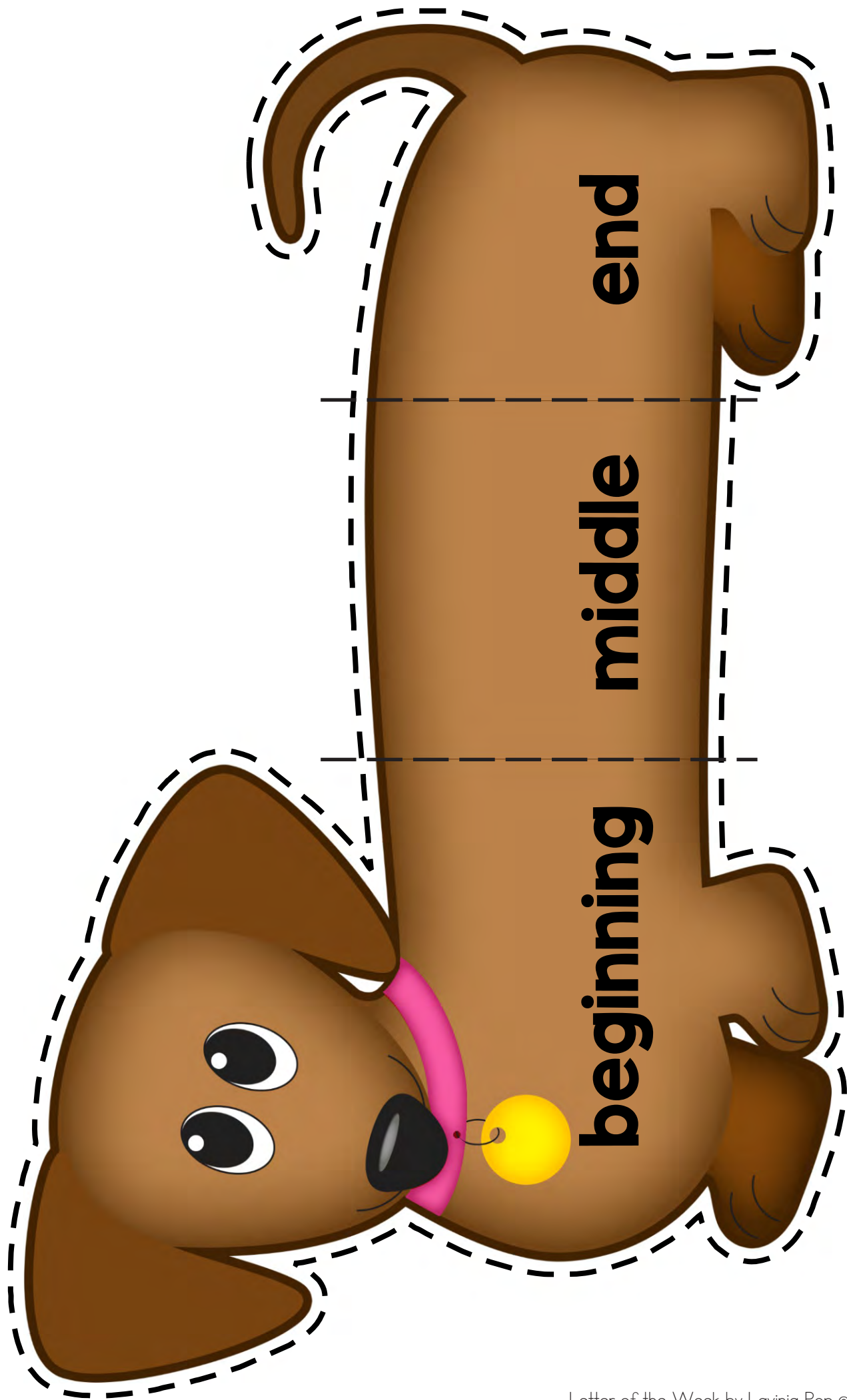

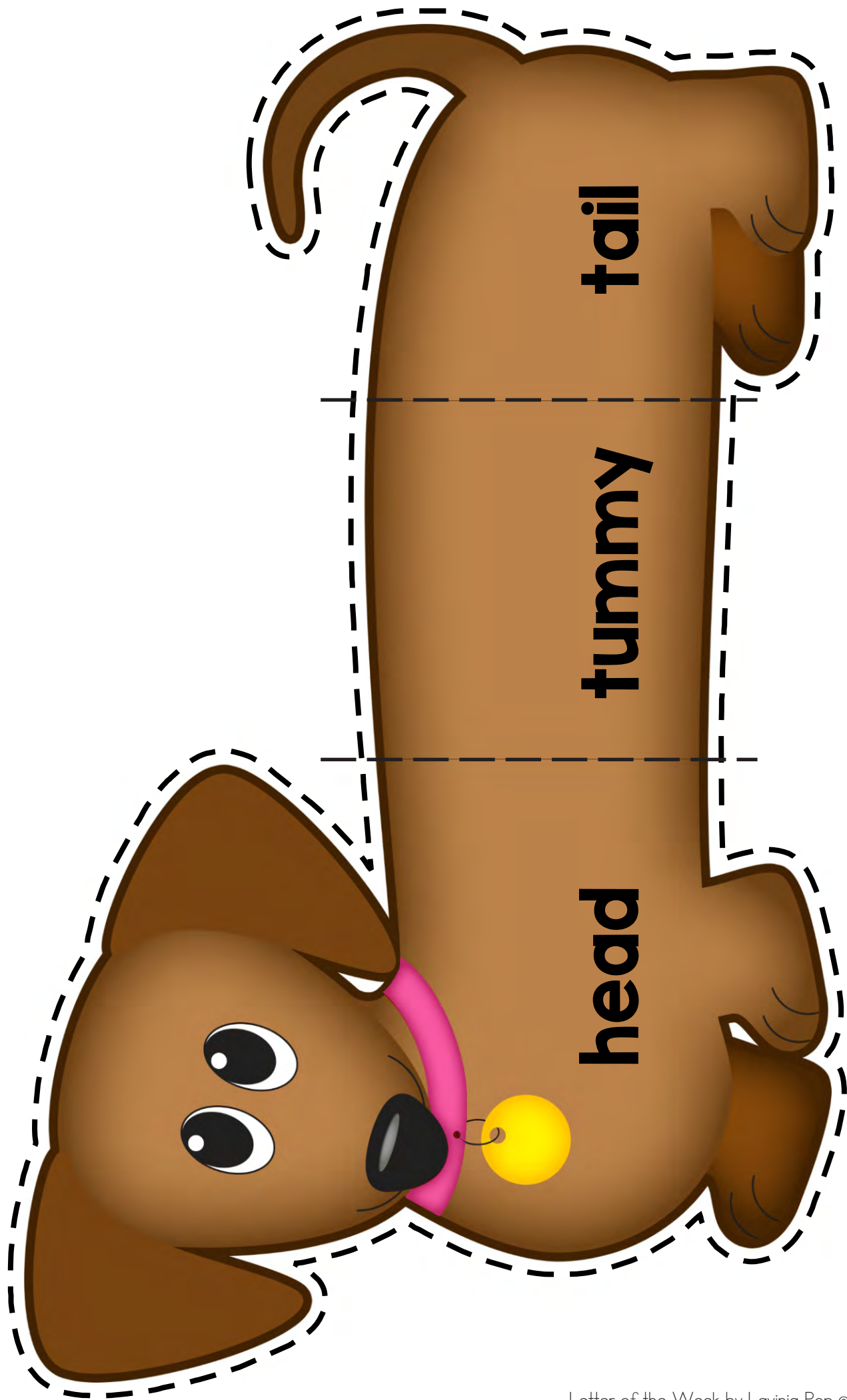

n



n



n



n



n



n



n

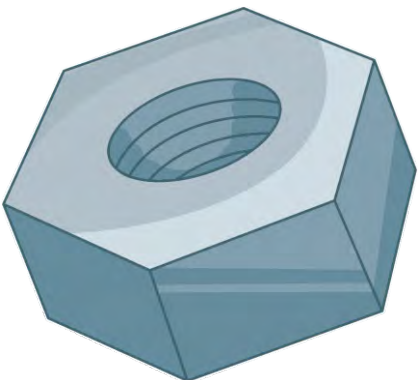

n



n



n



n



n



n

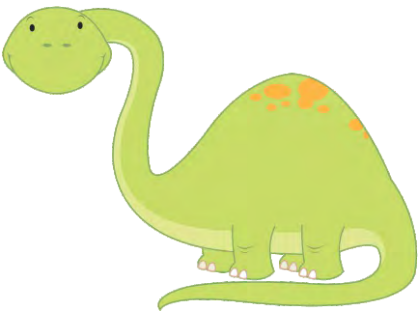

n



n



n



n



n



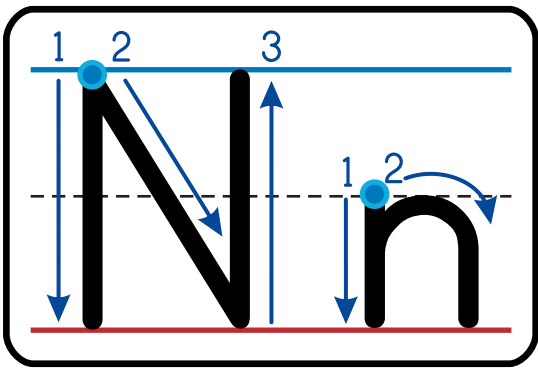

Name:

Sound Hound



Cut and paste the pictures in the columns below to show where you heard the sound.

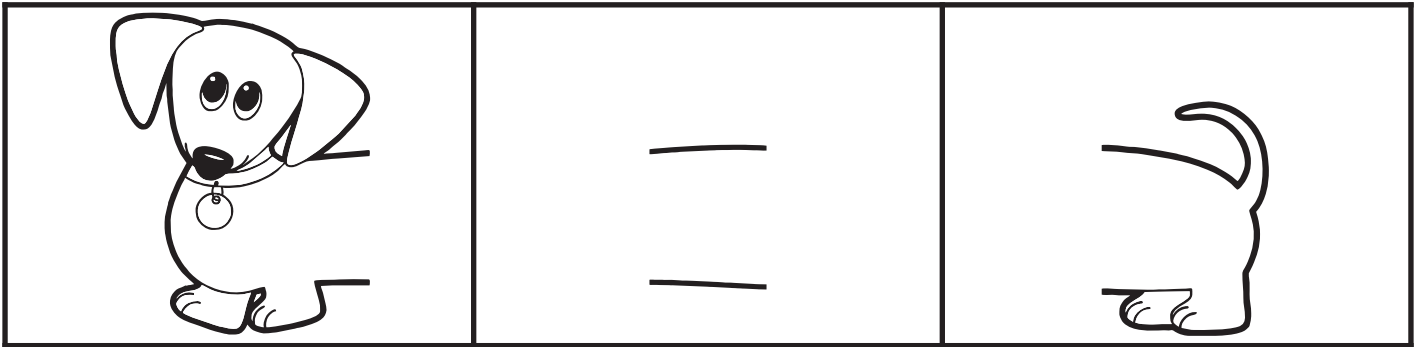

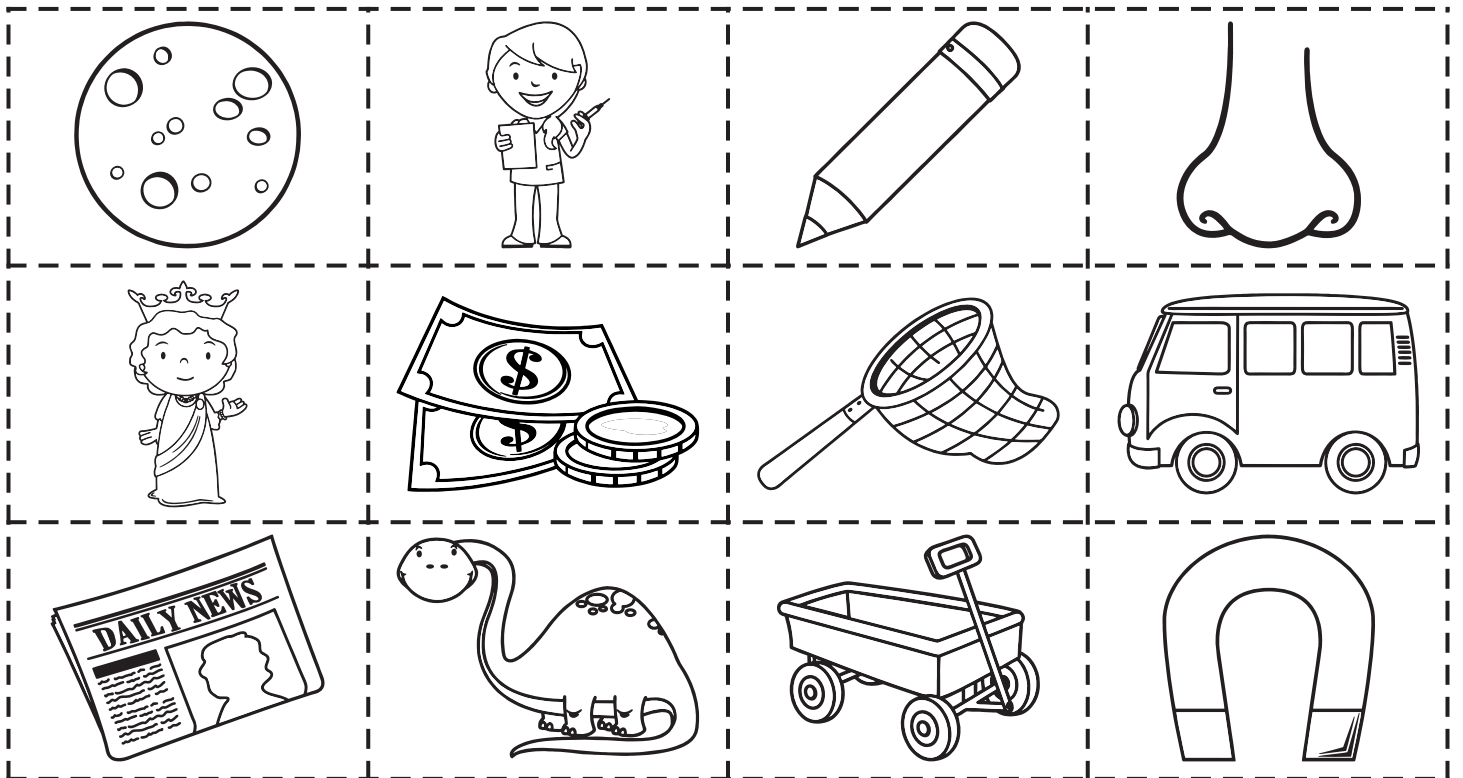
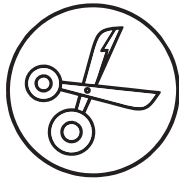
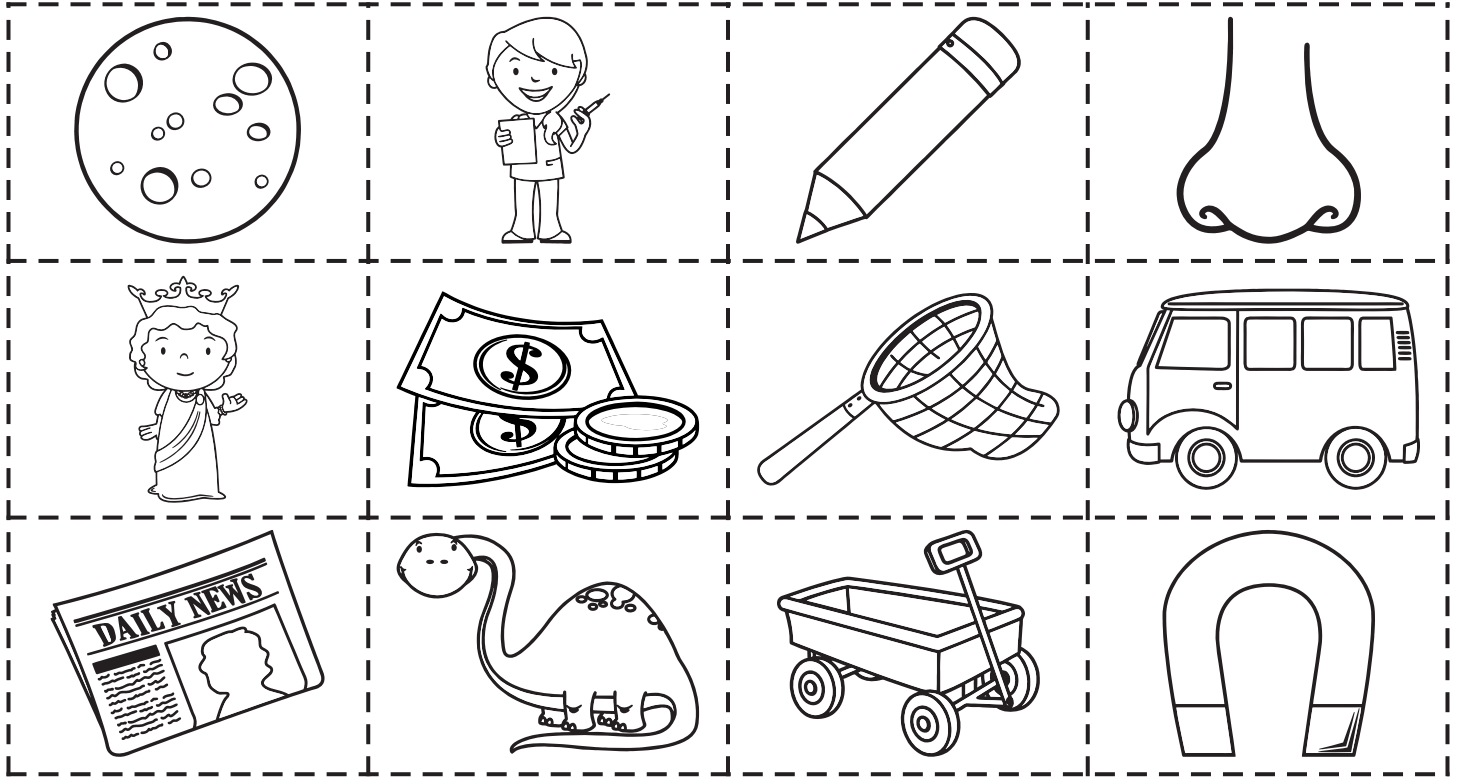
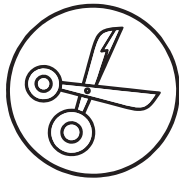



Ned

needs

the

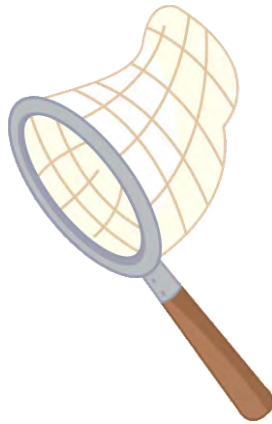

net.

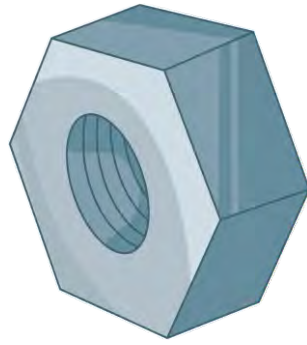

nut.



nest.

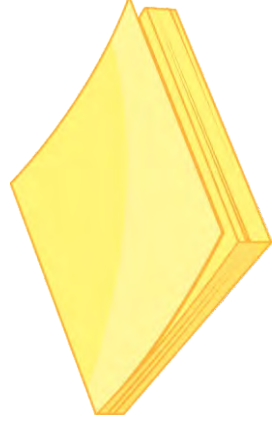

note.



newspaper.



necklace.



nurse.



nail.

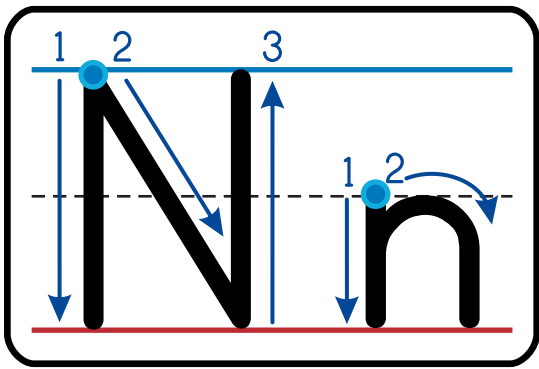

Name:

Build a Sentence

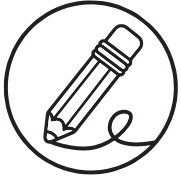

Trace and complete the sentence by writing words from the activity. Draw a picture to match each word.

Ned needs the

1 _____

2 _____

3 _____

4 _____

Name _____

By Lavinia Pop © 2013

I like this

Glue/Staple

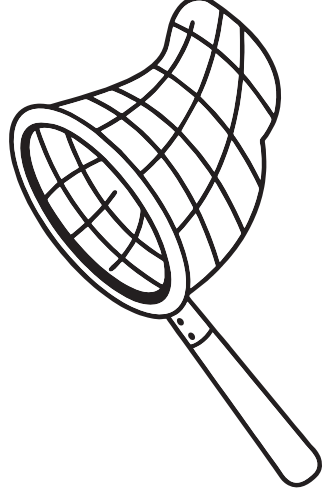

net.

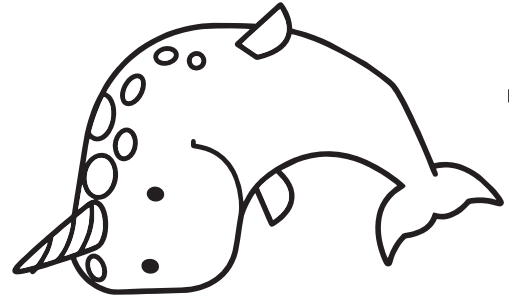

narwhal.

Glue/Staple



newspaper.

Glue/Staple

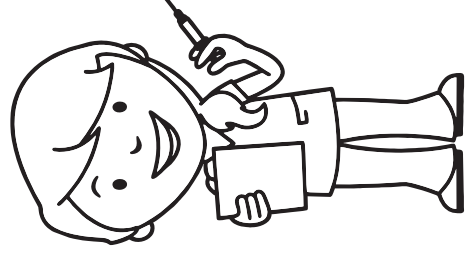

nurse.

Glue/Staple

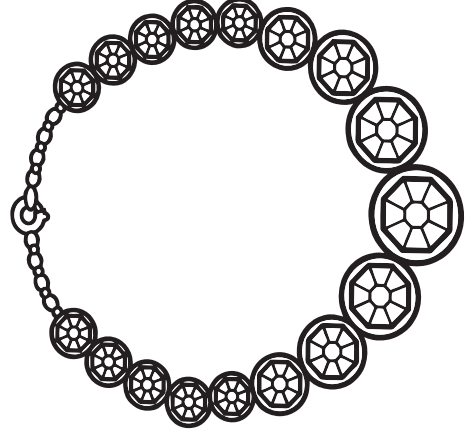

necklace.

Name _____

By Lavinia Pop © 2013

Glue/Staple

I like this

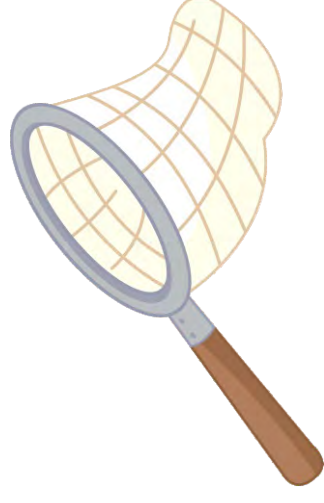

net.

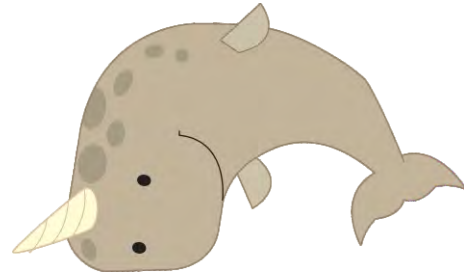

narwhal.



newspaper.



nurse.

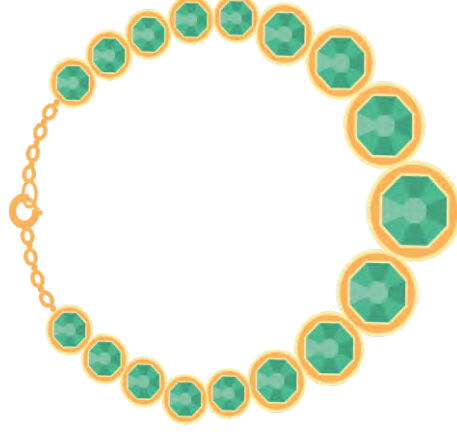

necklace.

Glue/Staple

Glue/Staple

Glue/Staple

Name:

Letter Nn

Write a sentence from your flip book using one word that begins with the letter "n".

The "n" word I chose is...

Another "n" word is...

A picture of my sentence:

Name: _____

Use your flip book to help you label the pictures.

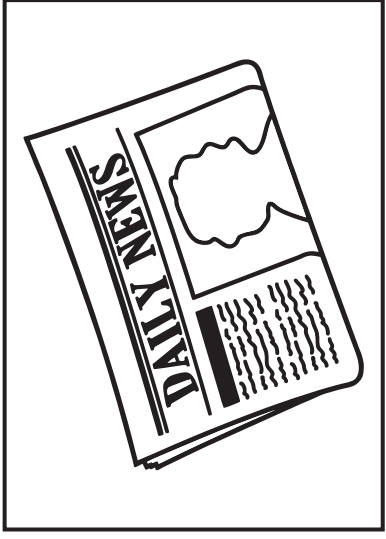
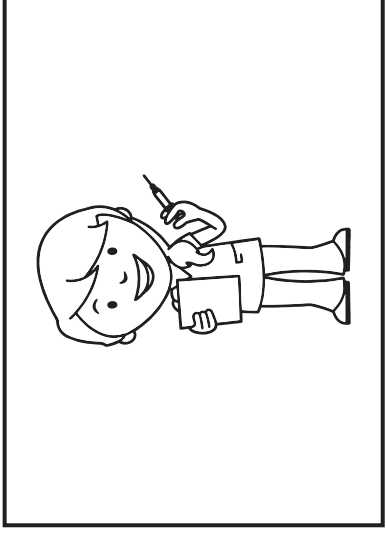

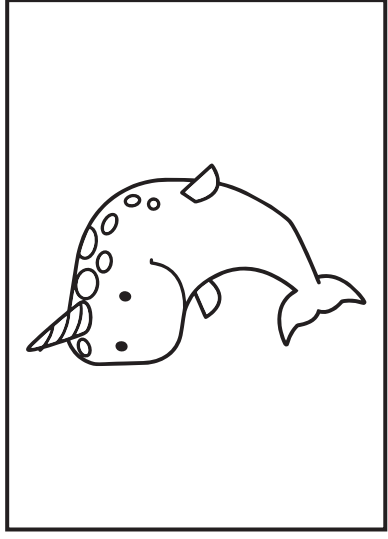
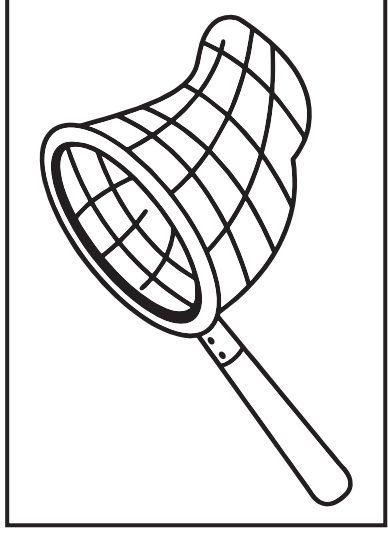

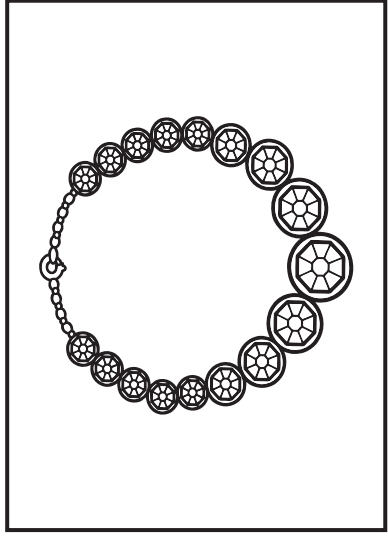
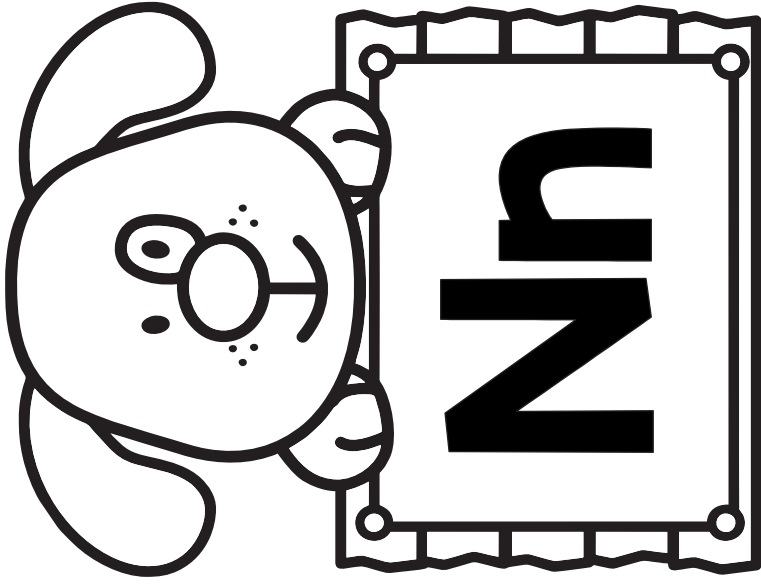

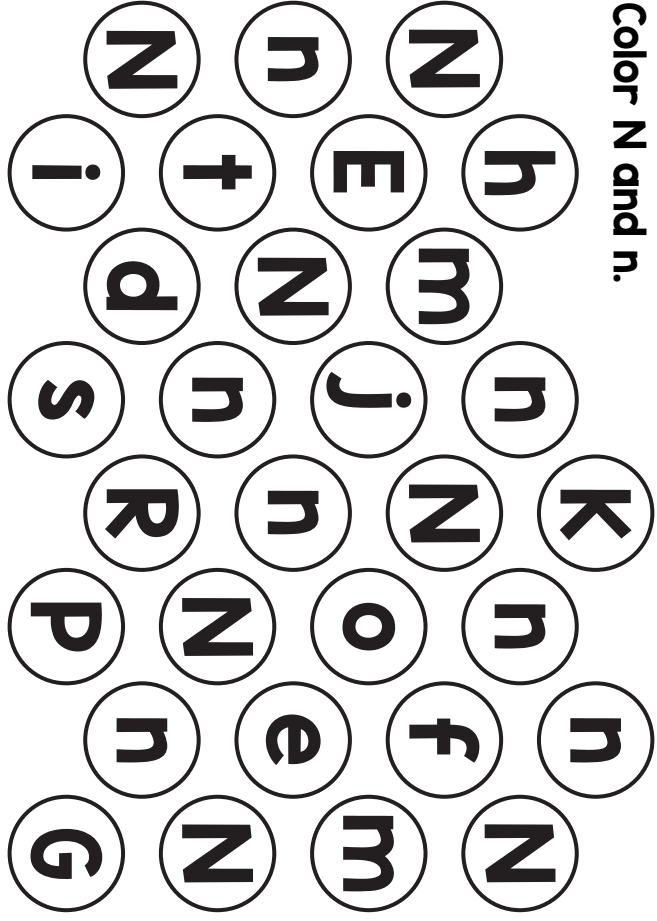

Color N and n.

Circle the pictures that begin with "n".

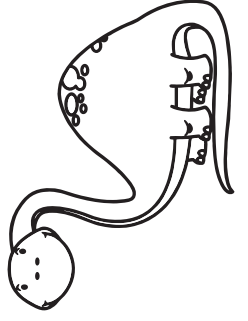
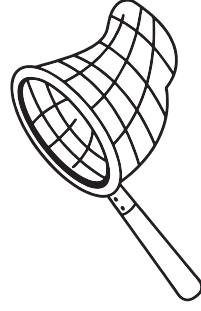
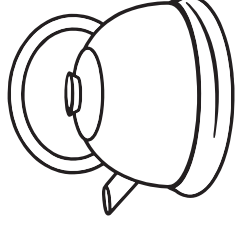
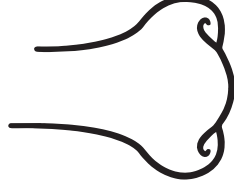
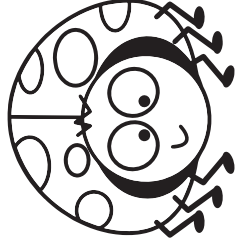

N n

M Y

B O O K

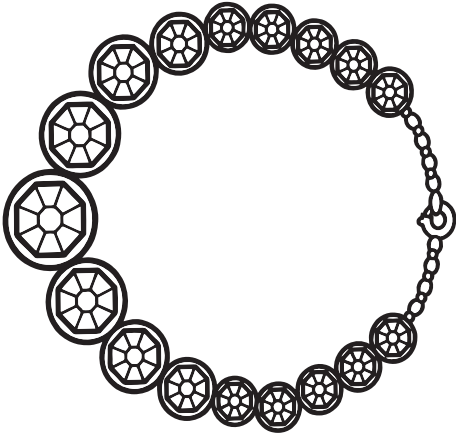

Name: _____

Trace the upper and lower case letters.

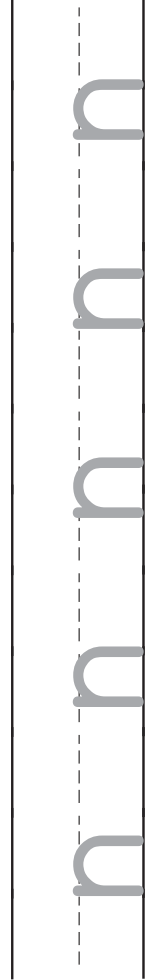
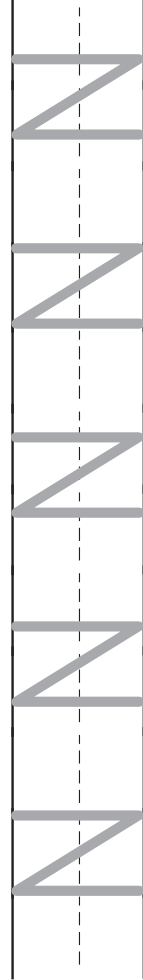

ALPHABET READER

Nn

Name

By Lavinia Pop © 2013

ALPHABET READER

Nn

Name

By Lavinia Pop © 2013

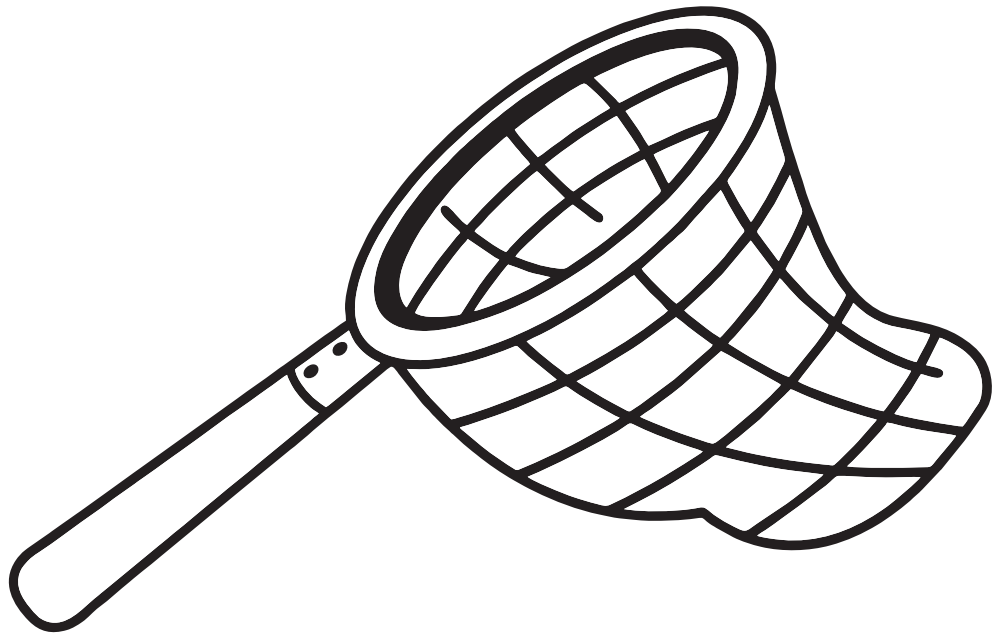

I will get a net.

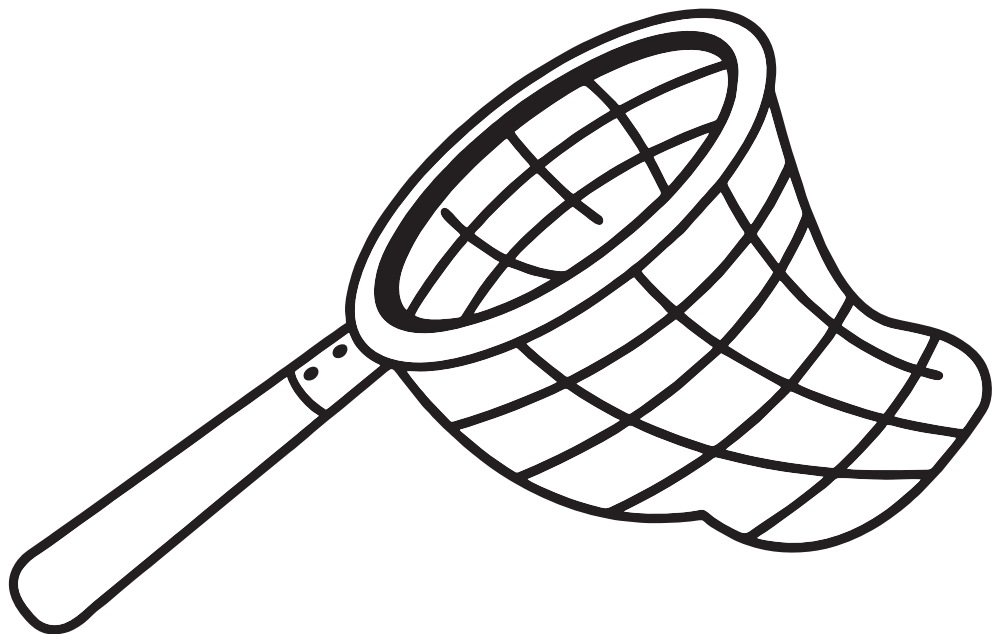

I will get a net.

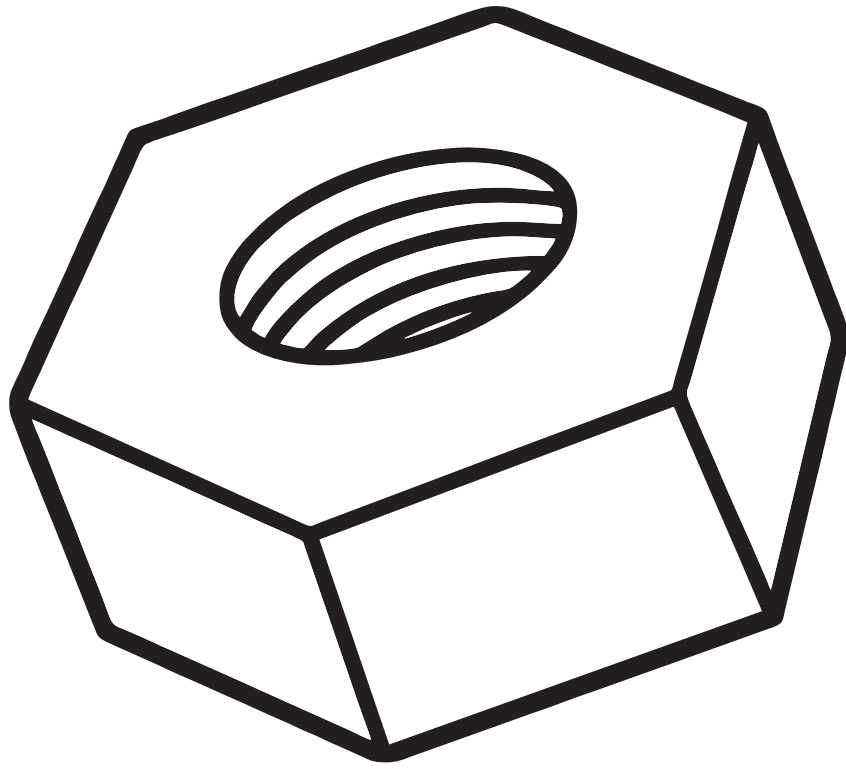

I will get a nut.

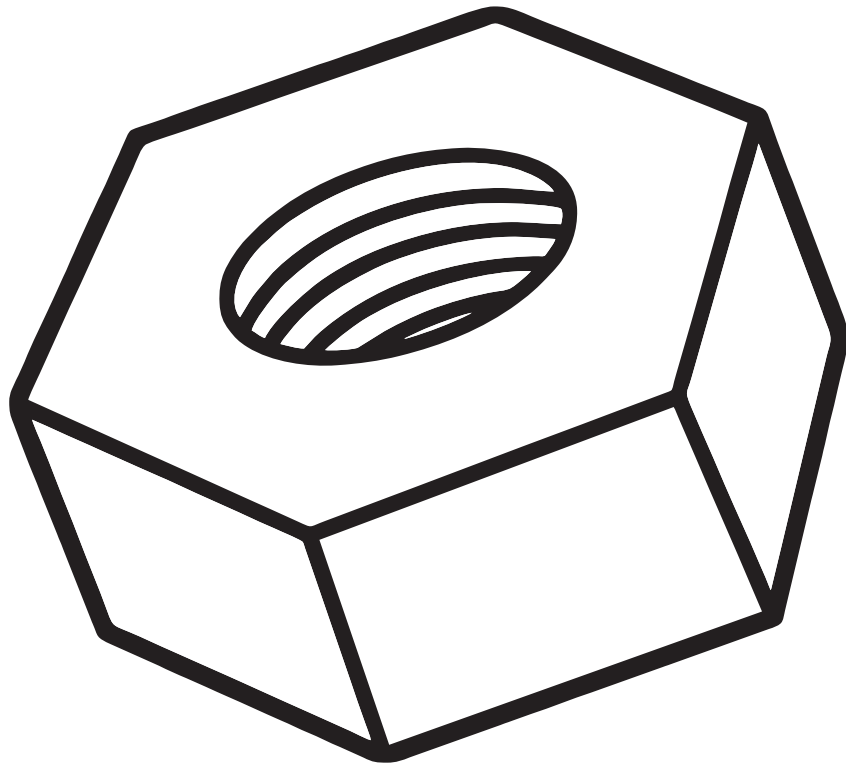

I will get a nut.



I will get a nest.



I will get a nest.

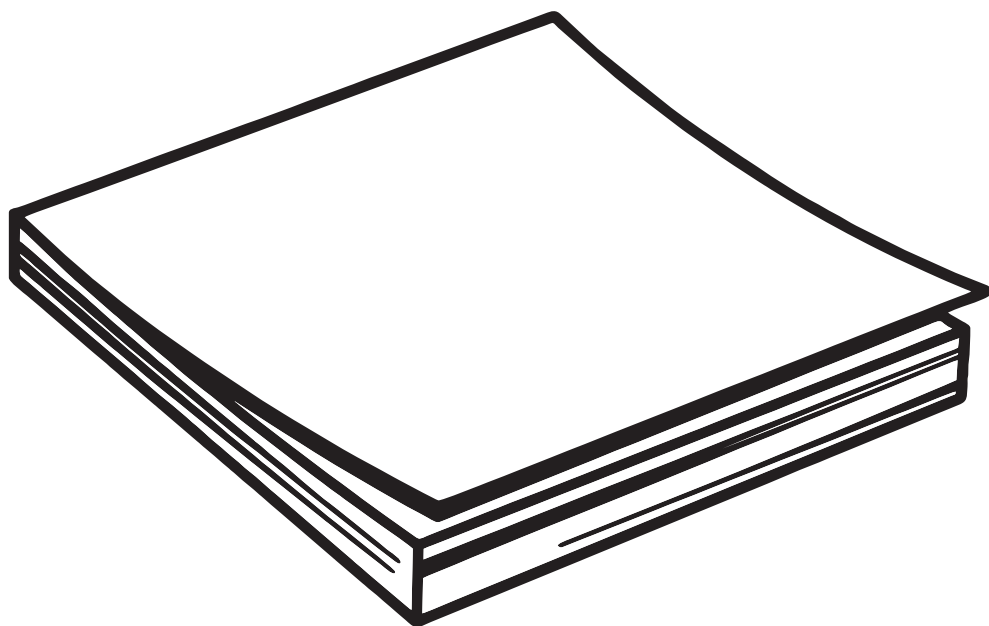

I will get a note.

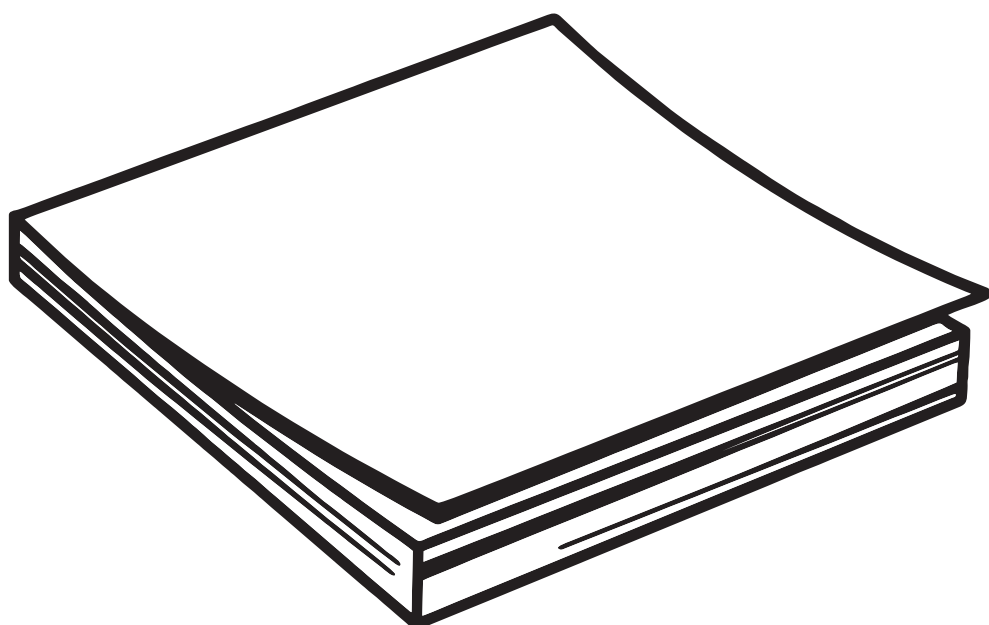

I will get a note.



I will get a nail.



I will get a nail.

ALPHABET READER

Nn

Name

By Lavinia Pop © 2013

ALPHABET READER

Nn

Name

By Lavinia Pop © 2013

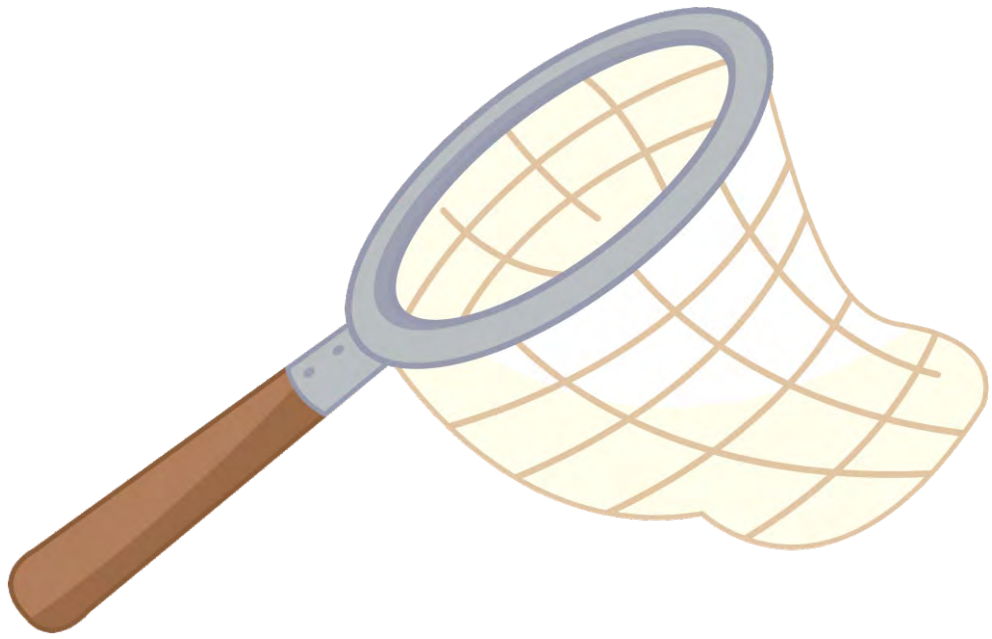

I will get a net.

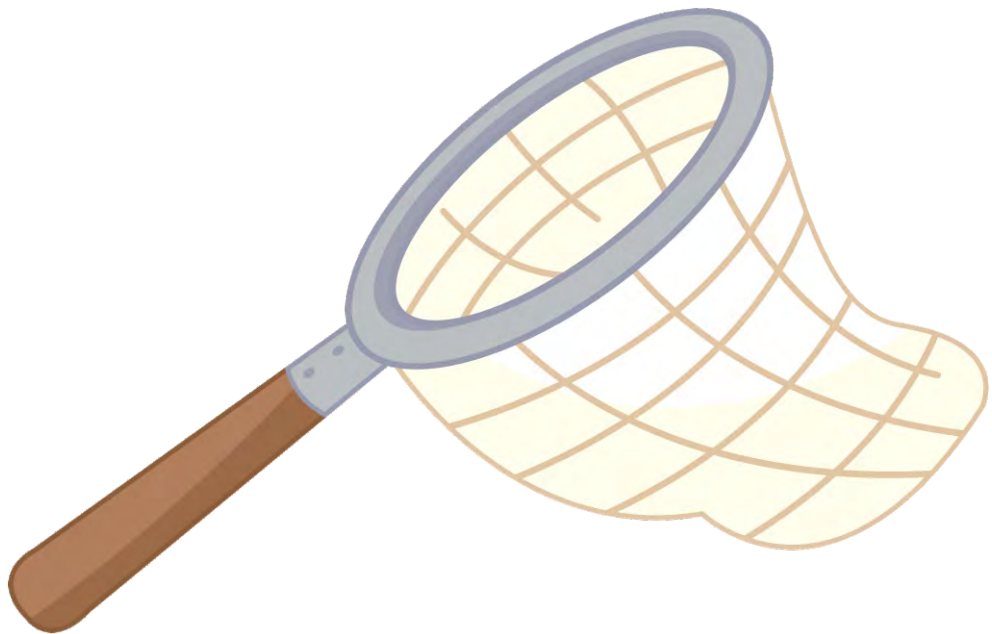

I will get a net.

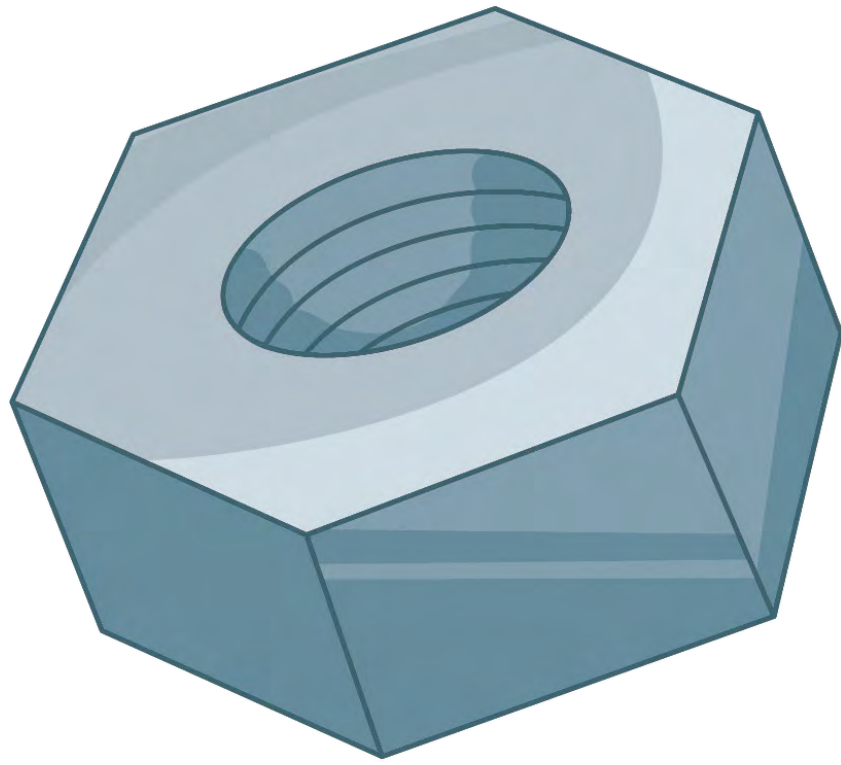

I will get a nut.

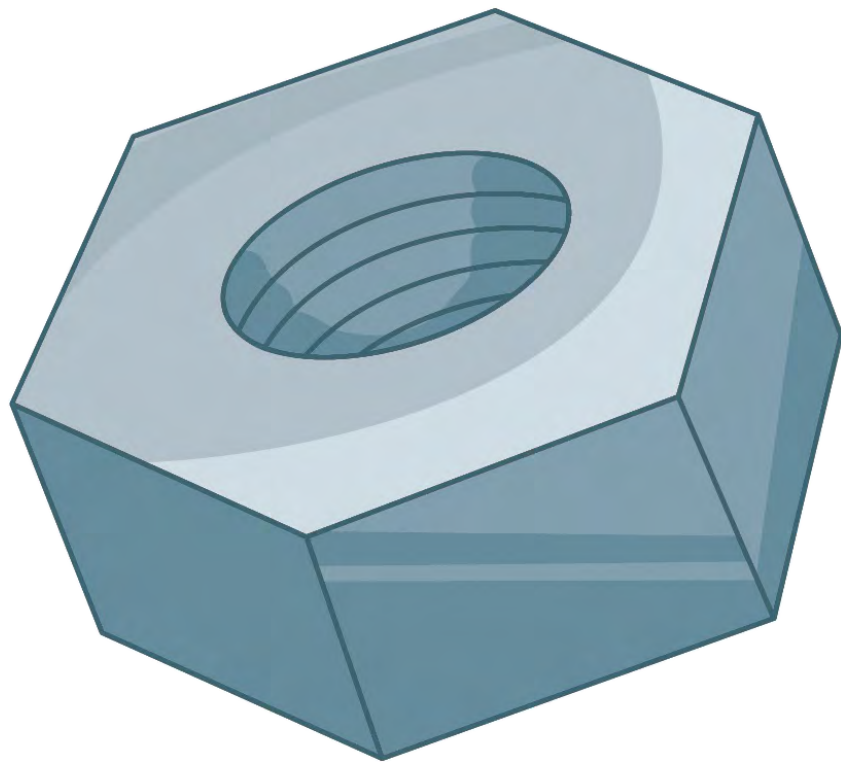

I will get a nut.



I will get a nest.



I will get a nest.

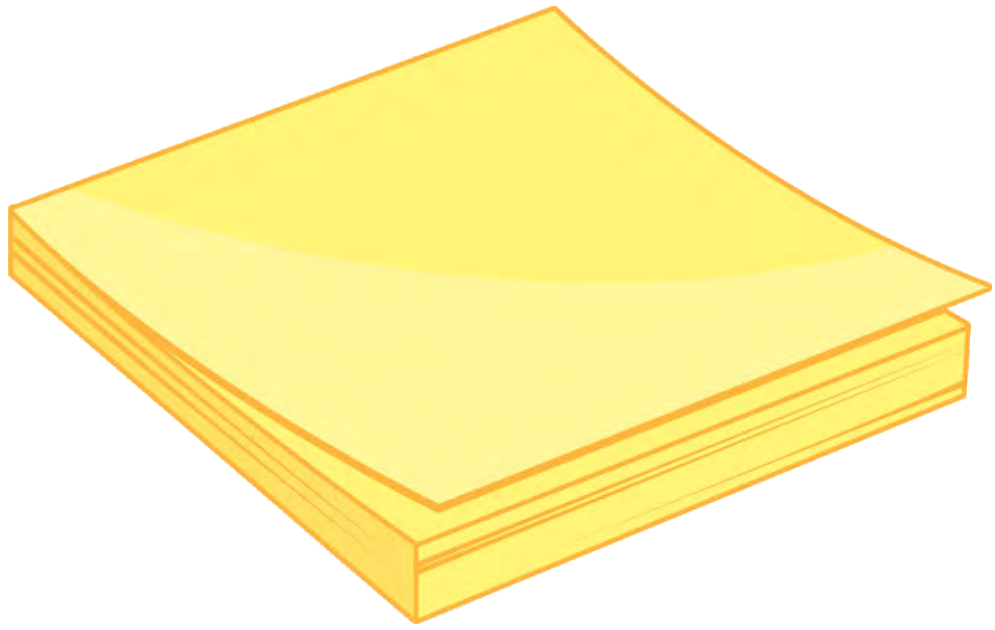

I will get a note.

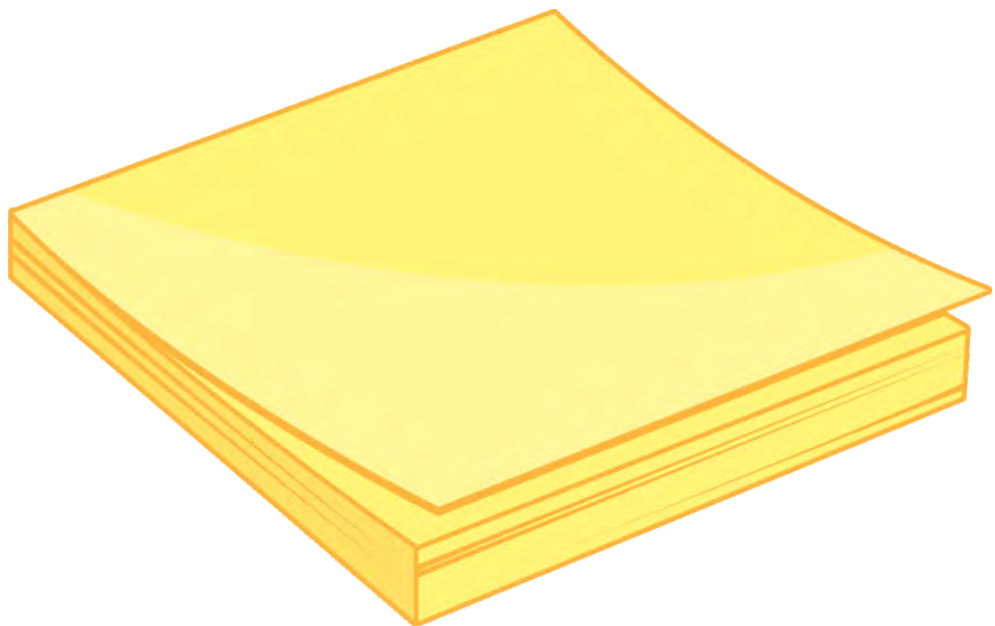

I will get a note.



I will get a nail.



I will get a nail.

M I S S I N G L E T T E R S

N n

Name

By Lavinia Pop © 2013

M I S S I N G L E T T E R S

N n

Name

By Lavinia Pop © 2013

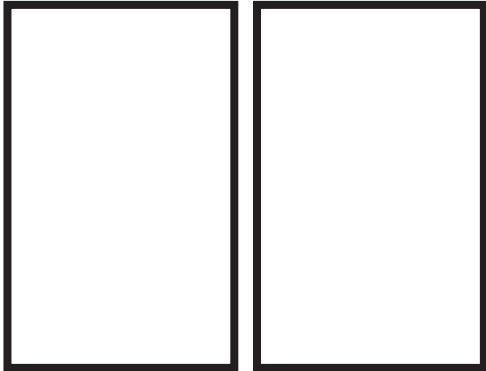

is for nap.

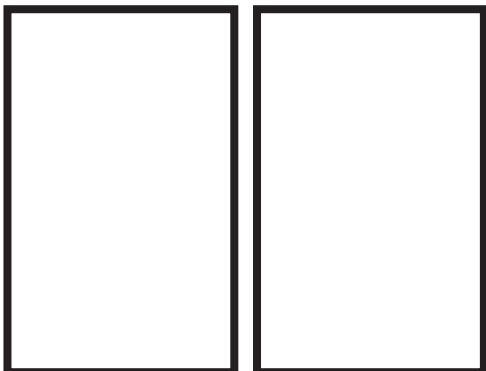

is for nap.

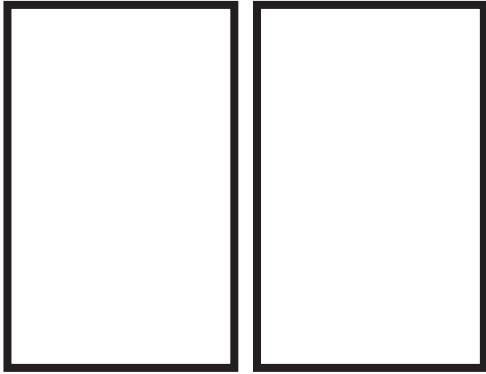

is for nurse.

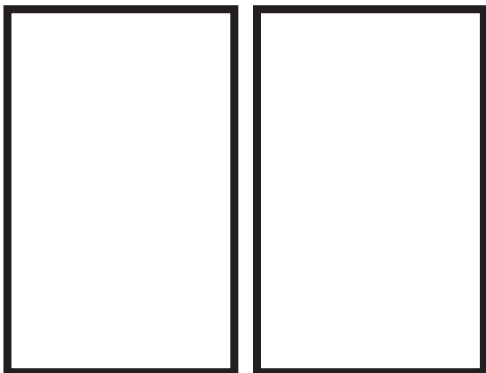

is for nurse.

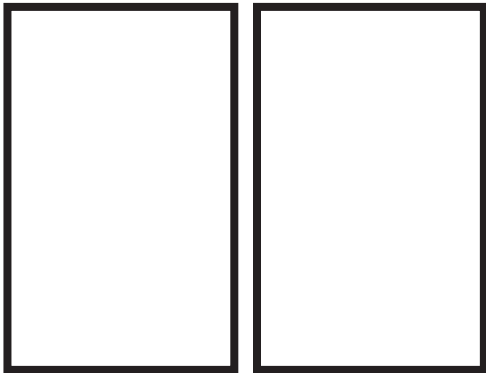
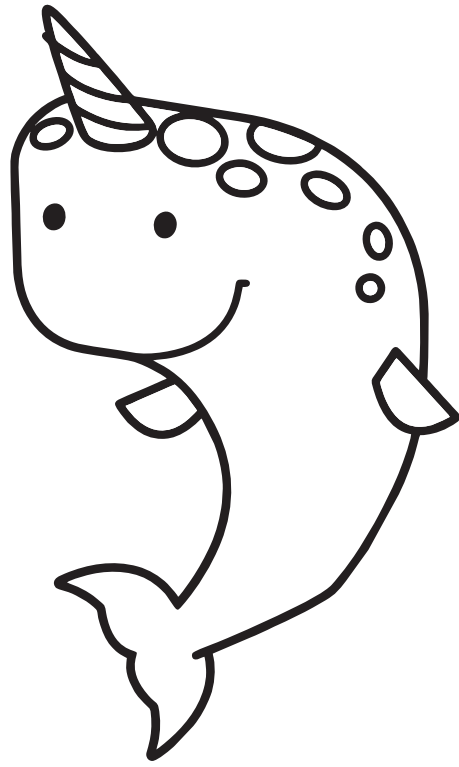

is for narwhal.

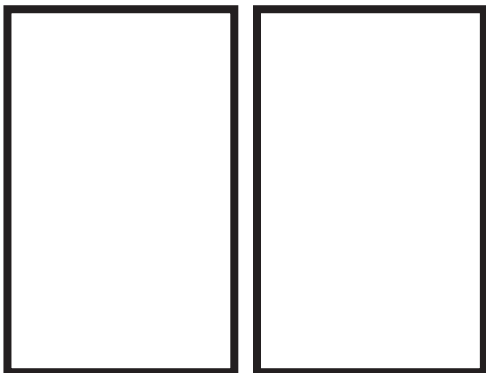
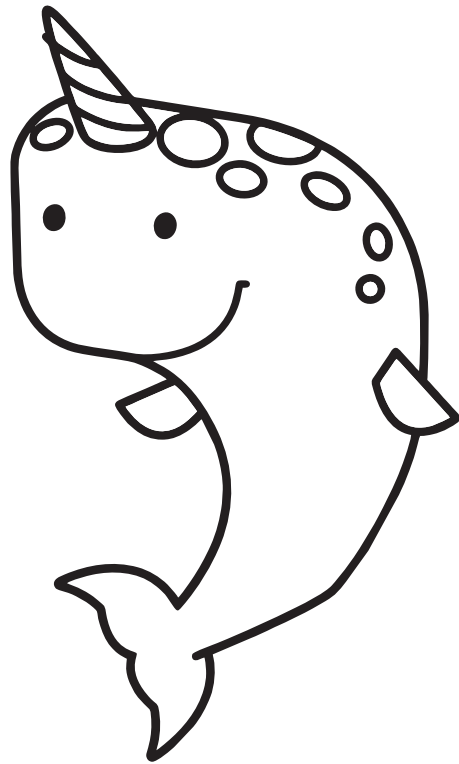

is for narwhal.

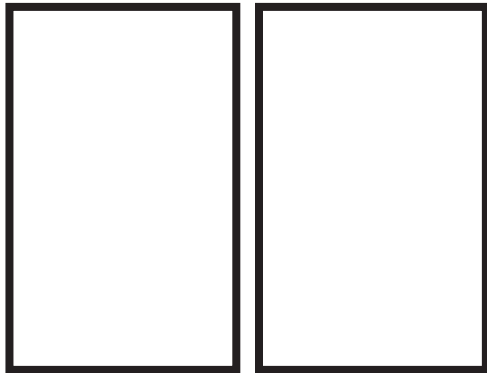
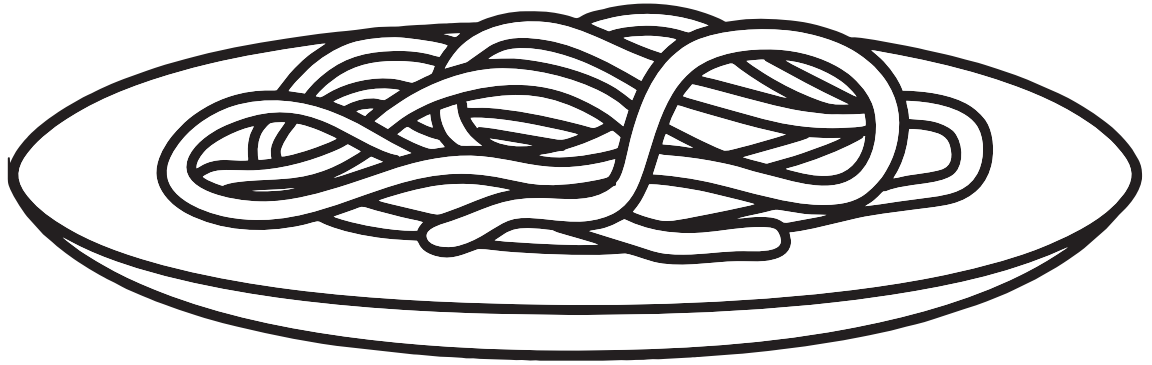

is for noodles.

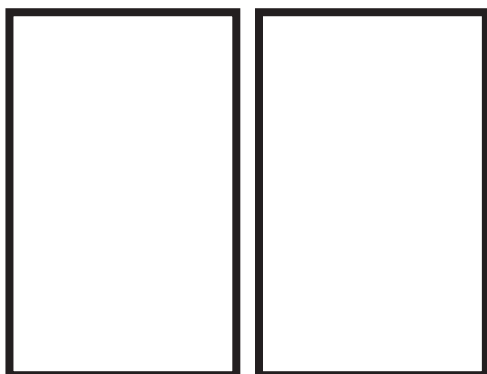
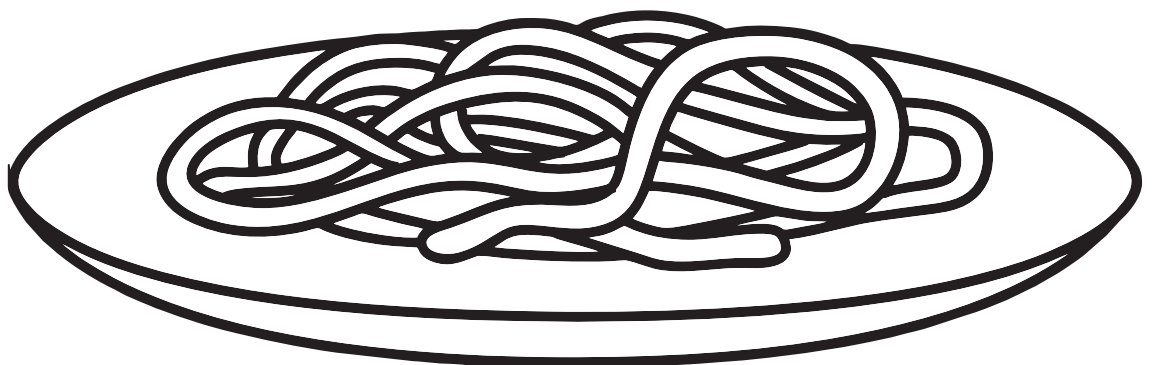

is for noodles.

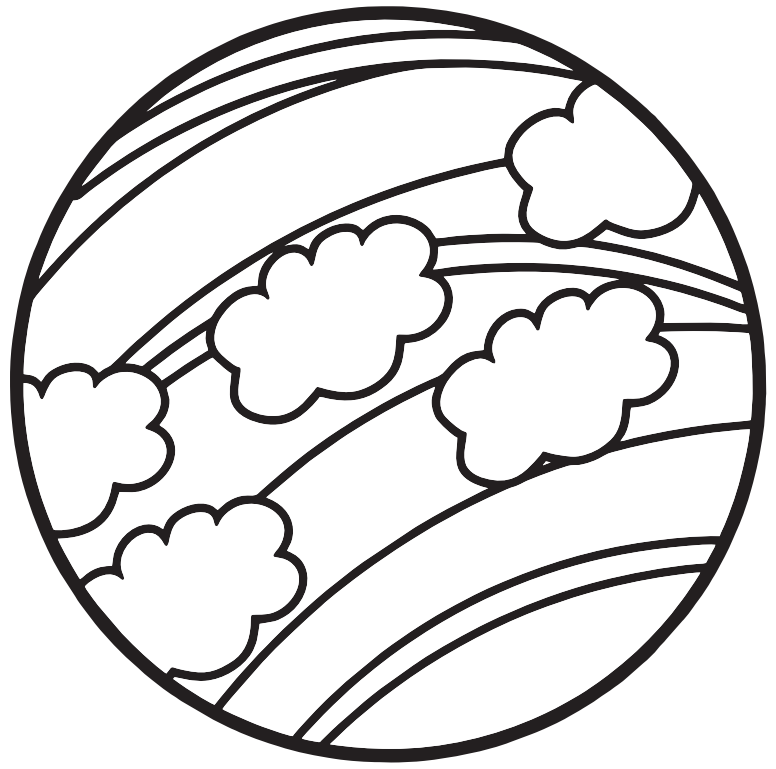

--	--

is for Neptune.

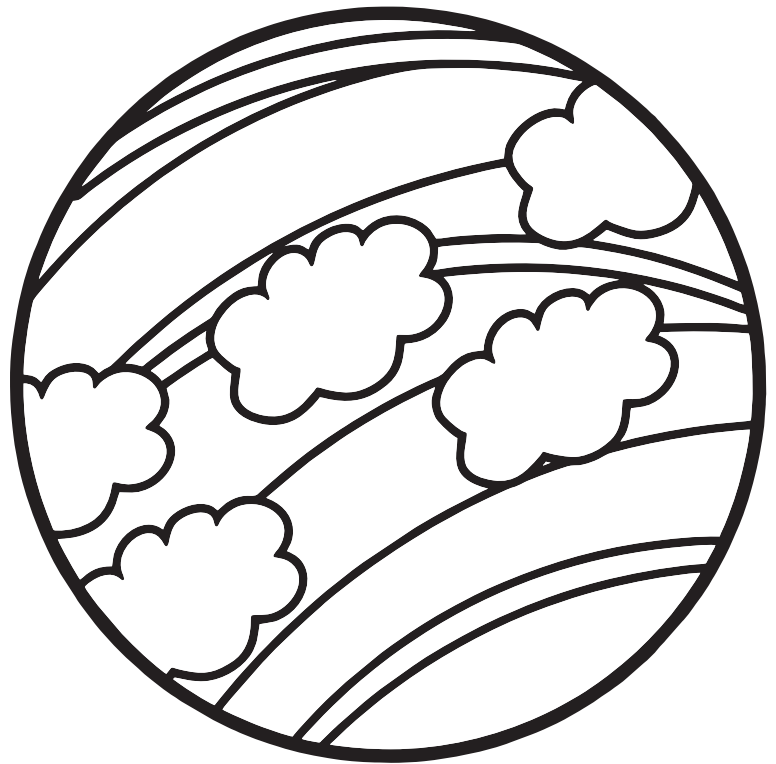

--	--

is for Neptune.

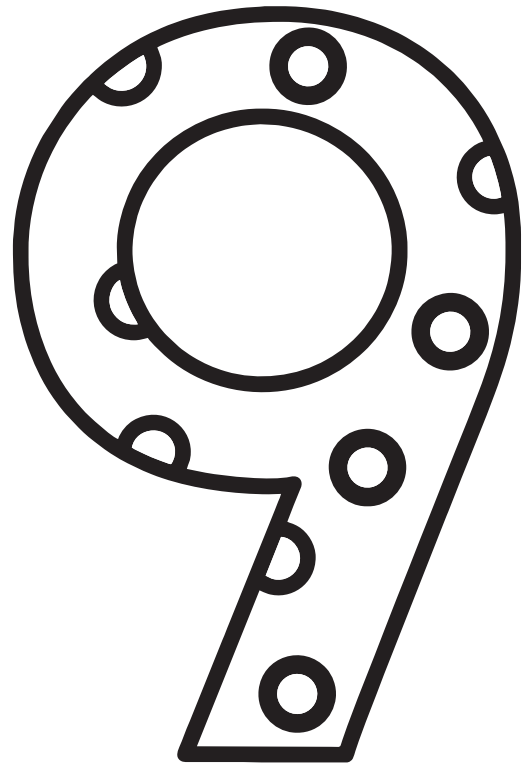

is for nine.

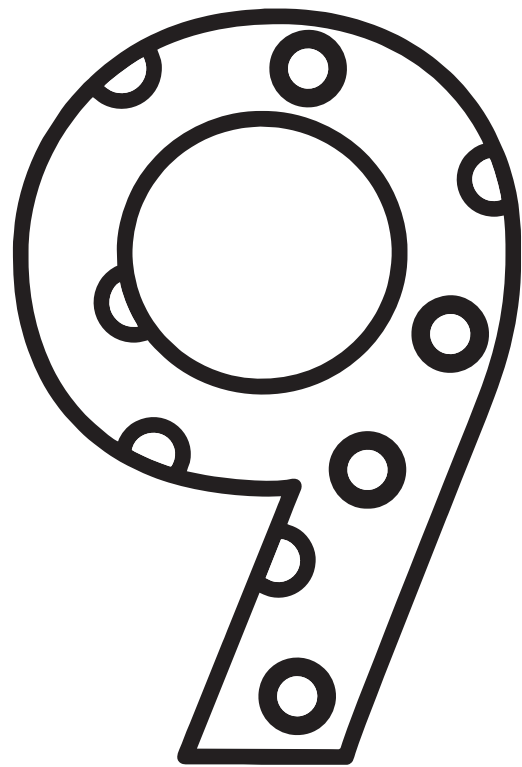
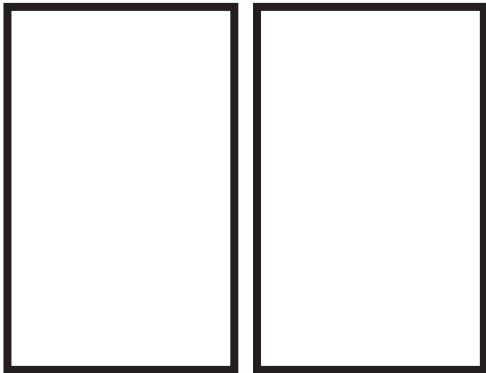

is for nine.

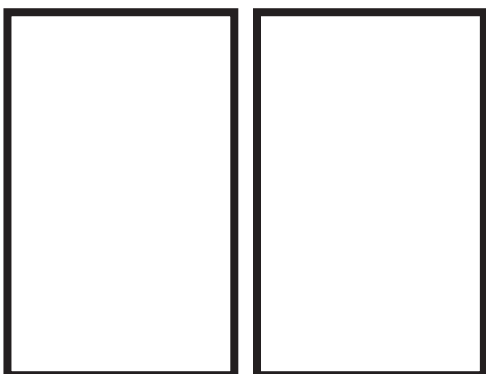

N n

N n

N n

N n

N n

N n

N n

N n

N n

N n

N n

N n

N n

N n

N n

N n

N n

N n

P i c t u r e S c r a m b l e

N n

**nap
net
nip
nit
nod
nut**

Name

By Lavinia Pop © 2013

P i c t u r e S c r a m b l e

N n

**nap
net
nip
nit
nod
nut**

Name

By Lavinia Pop © 2013

nap

nap

--	--	--

nap

nap

--	--	--

net

net

net

net

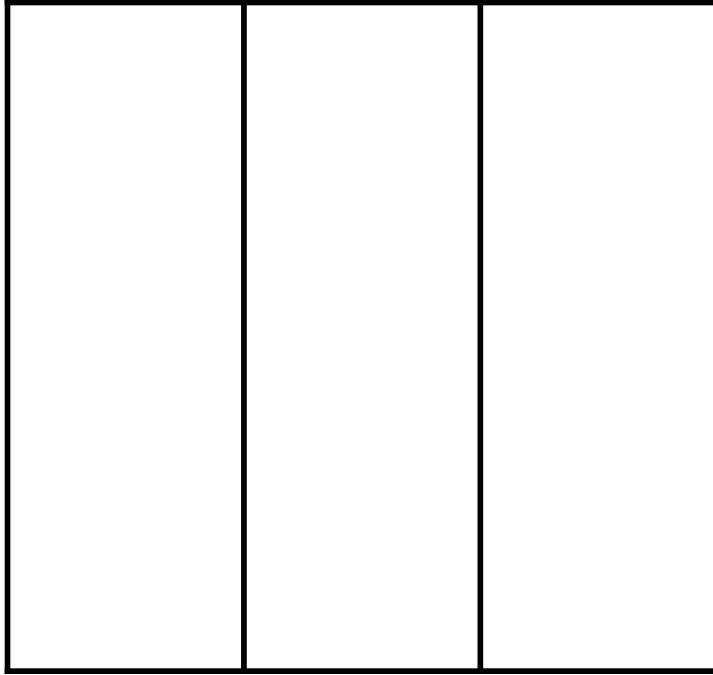

net

net

net

net

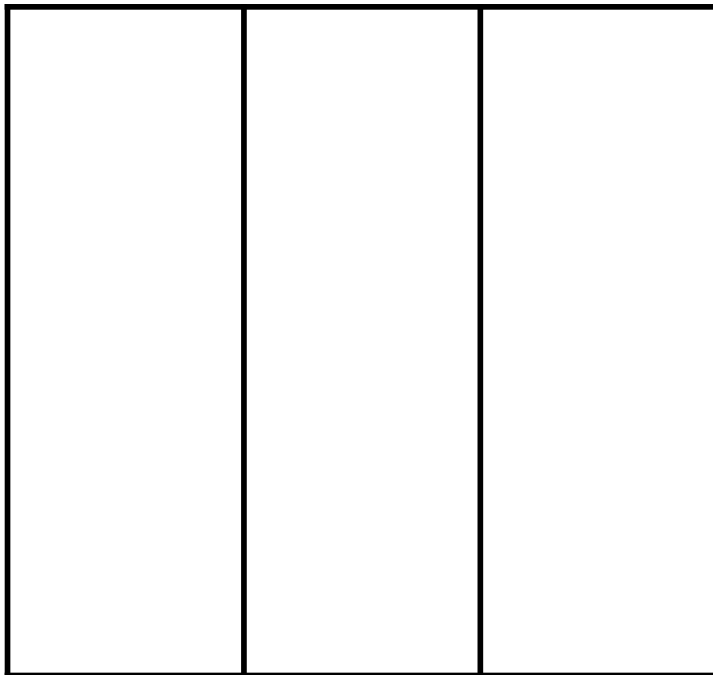

nip

--	--	--

nip

nip

--	--	--

nip

nit

--	--	--

nit

nit

--	--	--

nit

nod

nod

Blank handwriting practice lines for the word 'nod'.

--	--	--

nod

nod

Blank handwriting practice lines for the word 'nod'.

--	--	--

nut

nut

Blank handwriting lines for practice.

--	--	--

nut

nut

Blank handwriting lines for practice.

--	--	--



a

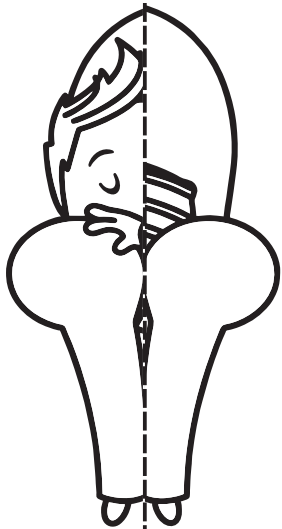

n

p

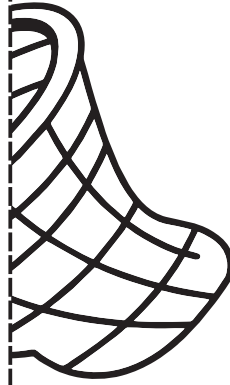

t



e

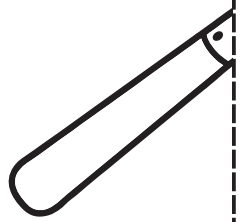

n

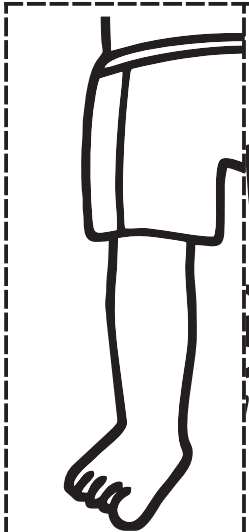

n



p

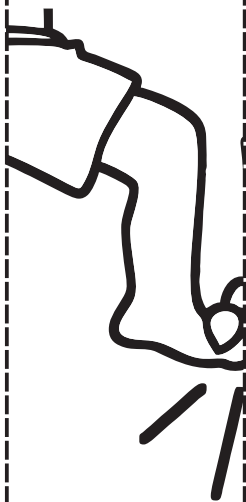

i



t

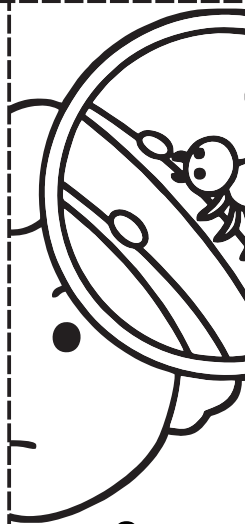

i

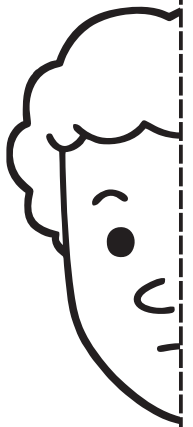

n

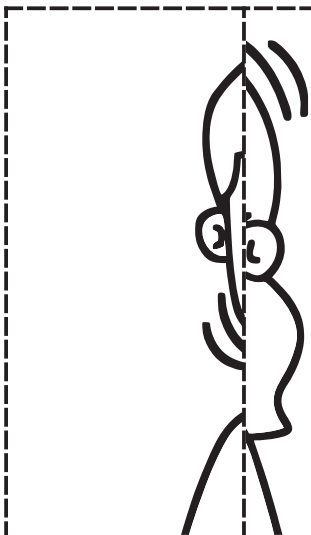

n

d



o



u

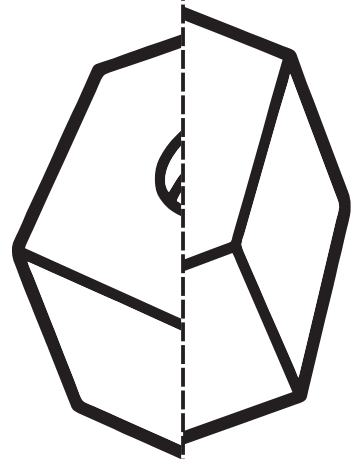

n

t

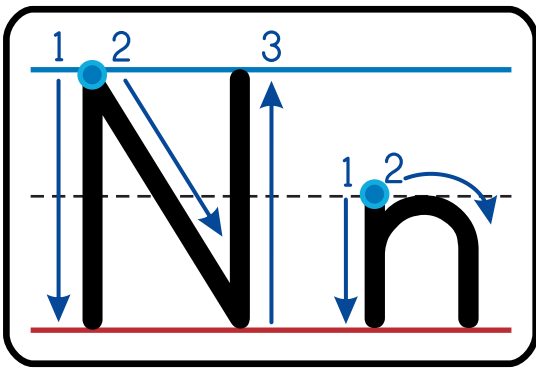

Name:

Letter Maze

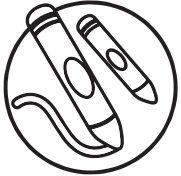

Help the nurse get to the note by following the N-n-N-n pattern through the maze.



N	n	N	z	d	o	q
g	a	n	h	L	T	V
t	f	N	I	U	I	C
e	S	n	N	n	N	s
y	n	f	l	b	n	v
s	T	z	r	y	N	I
P	n	N	n	N	n	O
d	N	o	C	f	g	r
c	n	N	n	N	n	N

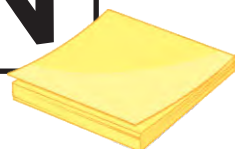

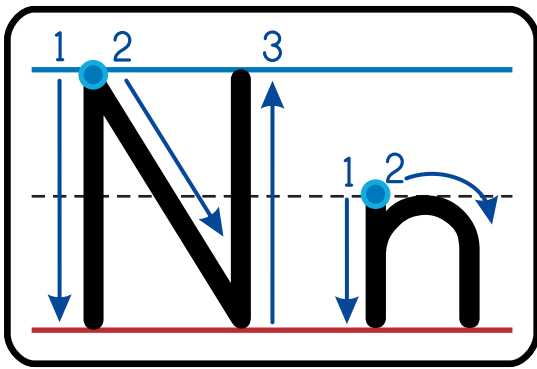

Name:

Font Maze

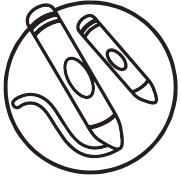

Follow the different Nn's through the maze.

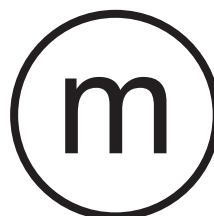
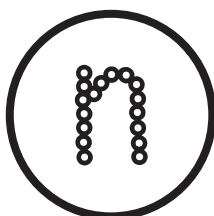
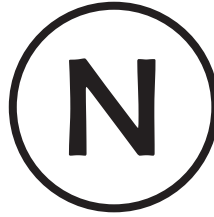
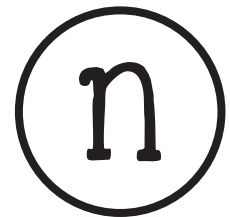
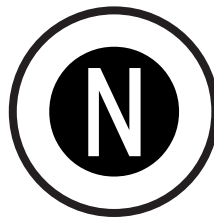
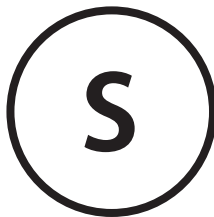

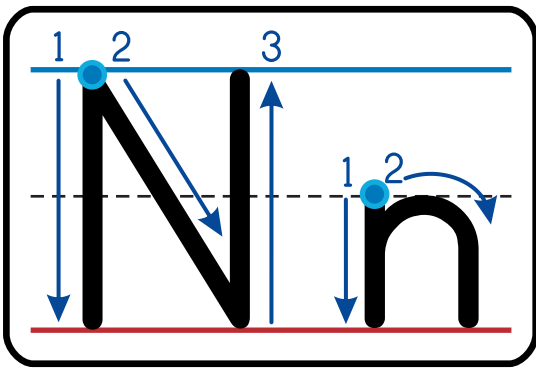

Name:

Hidden Letter

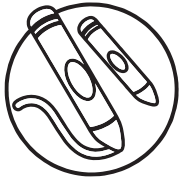

Color the sections using the code to reveal the hidden letter.

N



n



N		n	n	N
N	N		n	N
N		N		N
N	N		N	
N		n		N
N	N	n	n	N

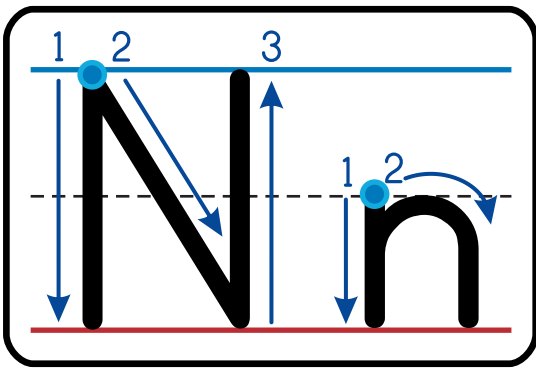

Name:

Hidden Letter

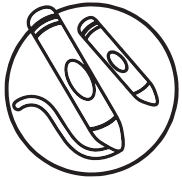

Color the sections using the code to reveal the hidden letter.

N



n



N	N	N	N	N
N	n	n	n	N
N	n	N	n	N
N	n	N	n	N
N	n	N	n	N
N	N	N	N	N

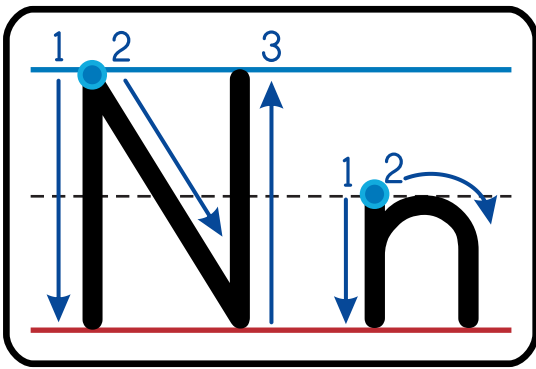

Name:

Beginning Sounds

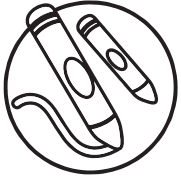

Color the pictures that begin with the Nn sound.

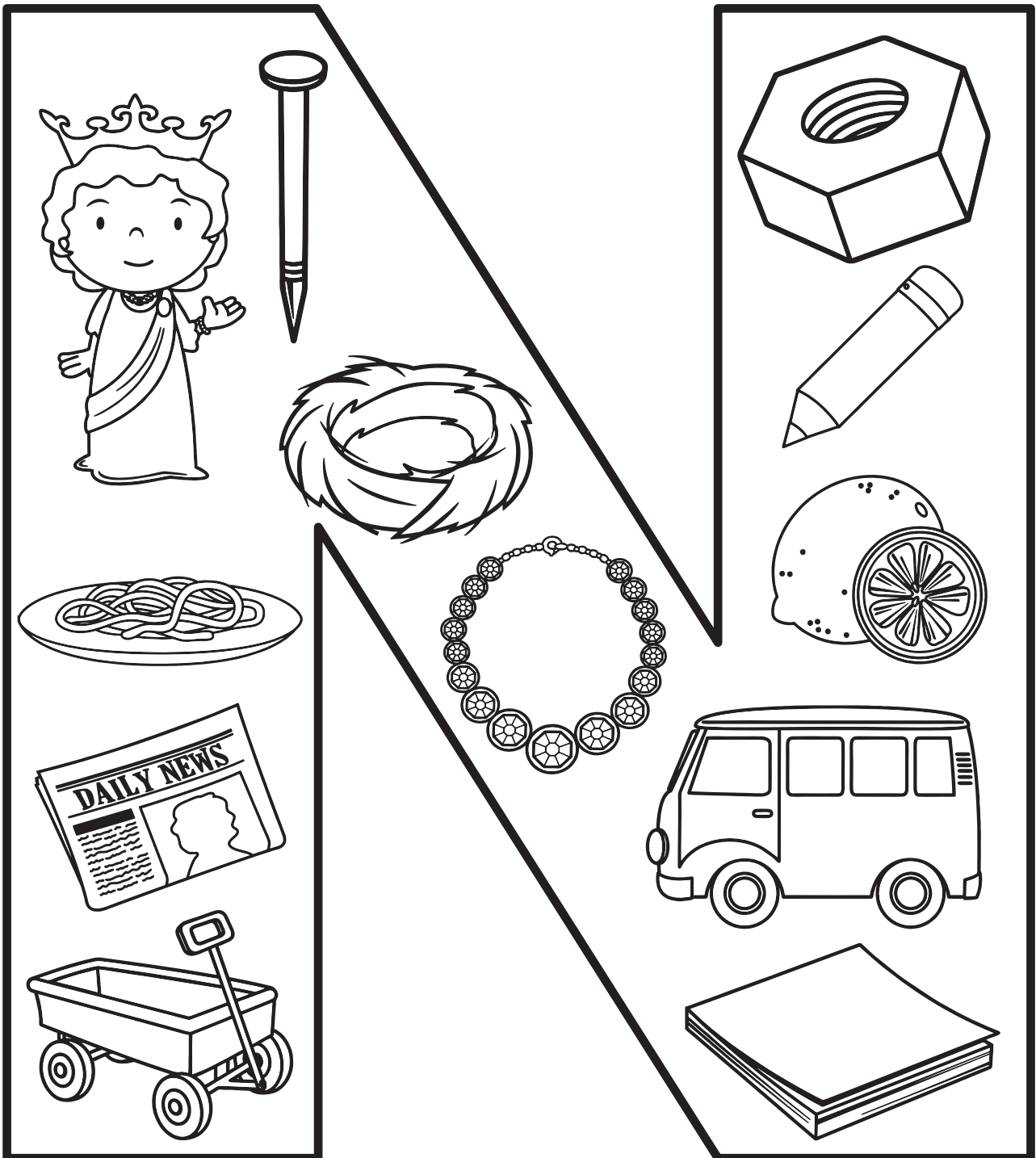

Name: _____

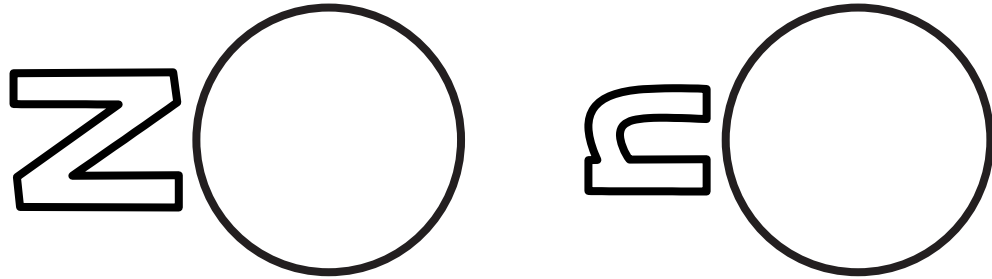
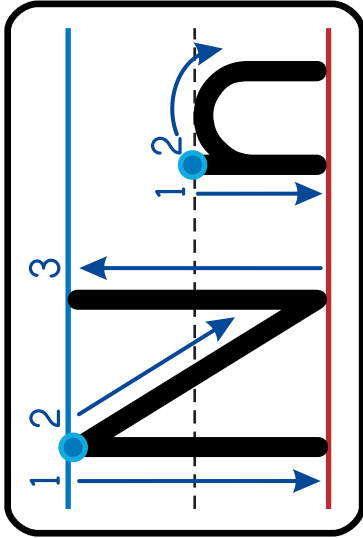

Letter Find

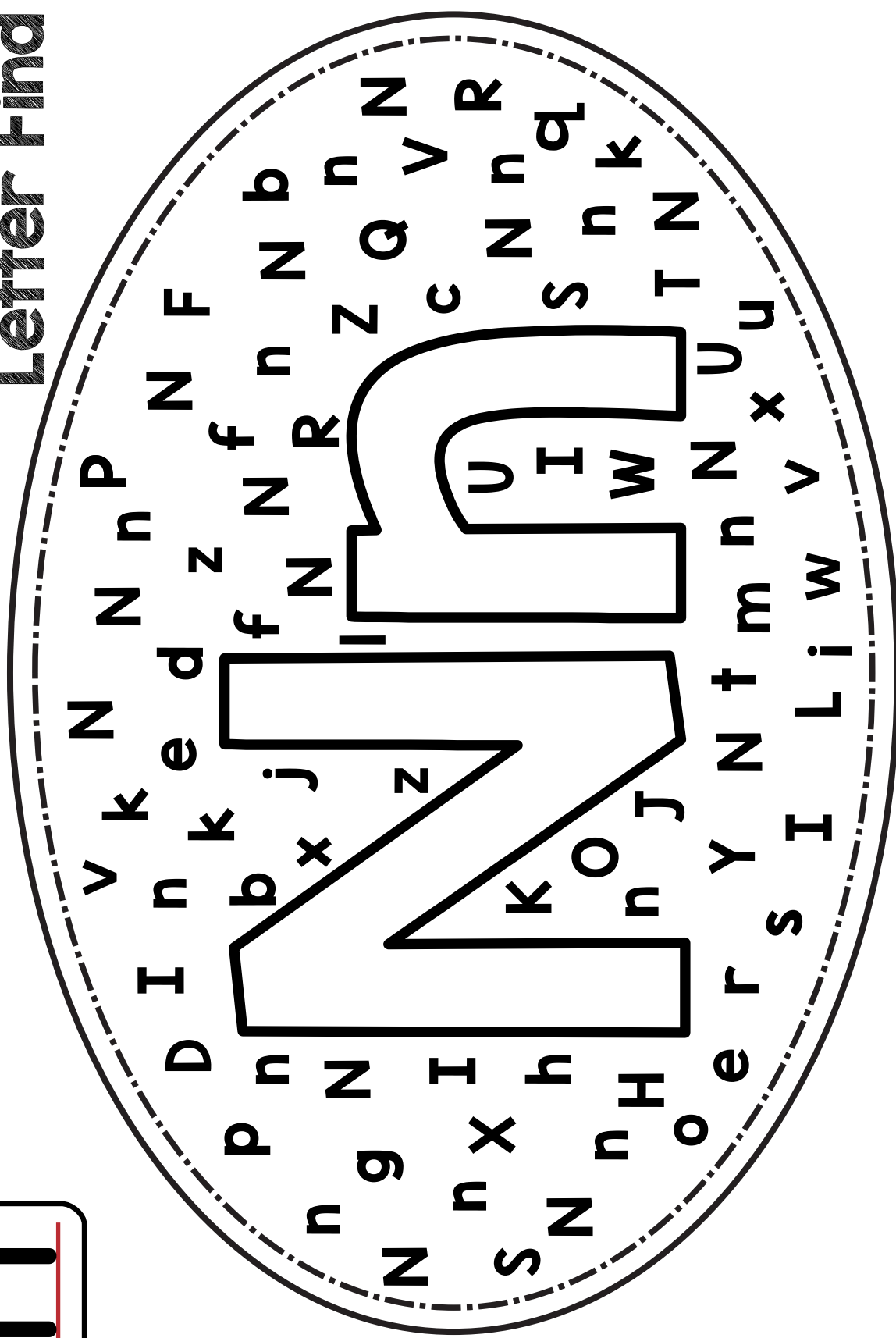

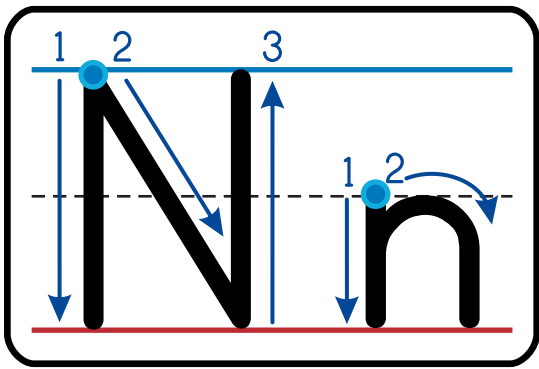

Name: _____

Handwriting

nap

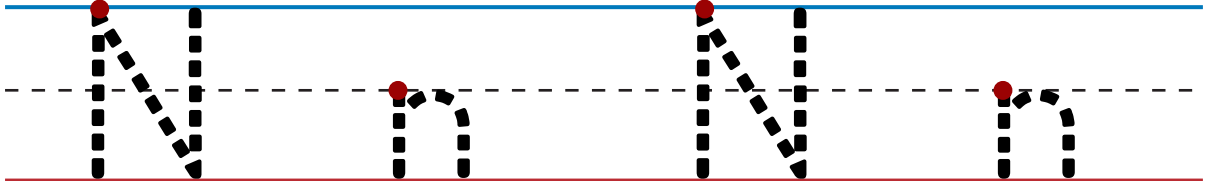
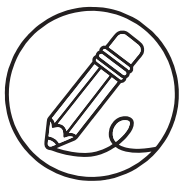
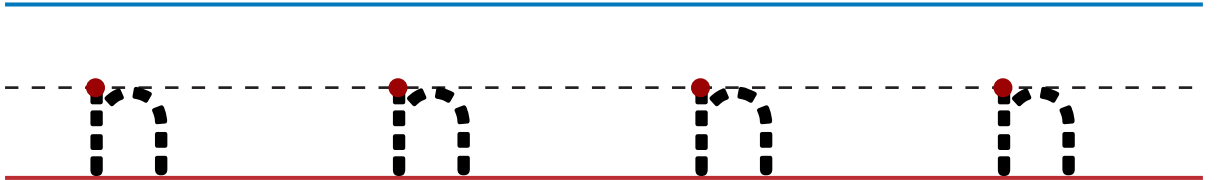
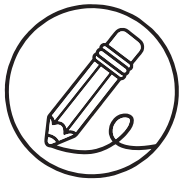
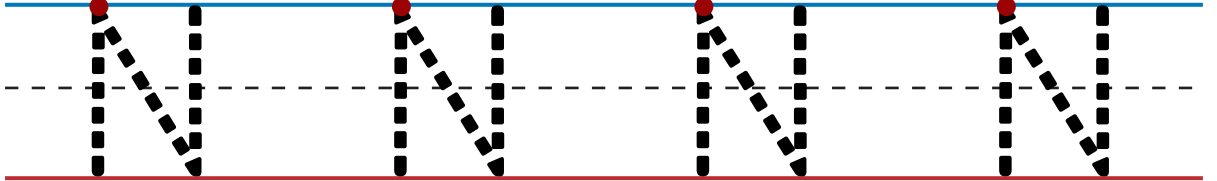
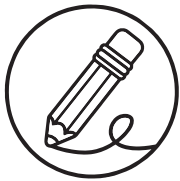
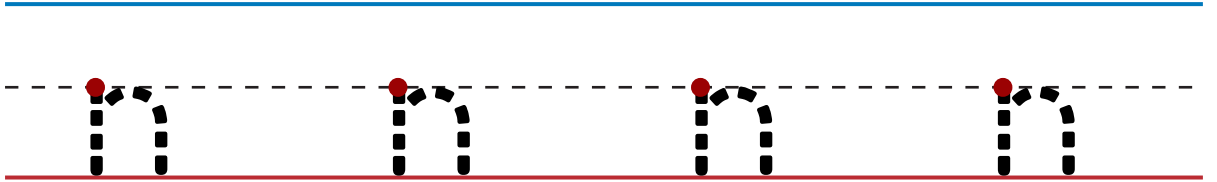
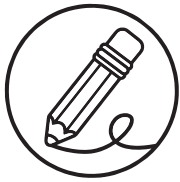
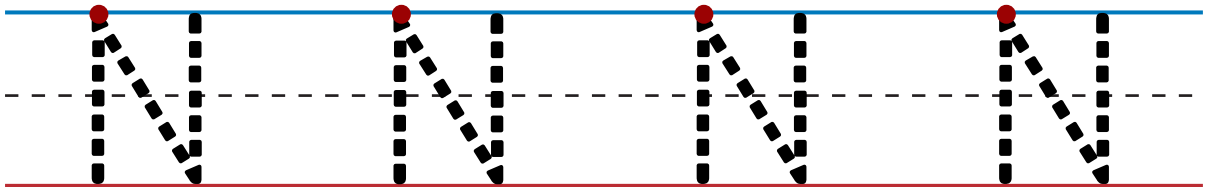
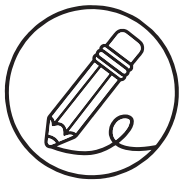

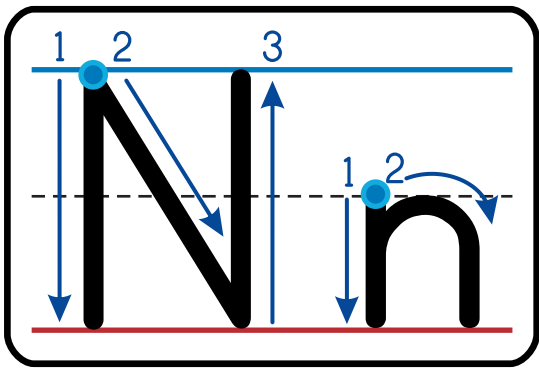

Name:

Handwriting



nap

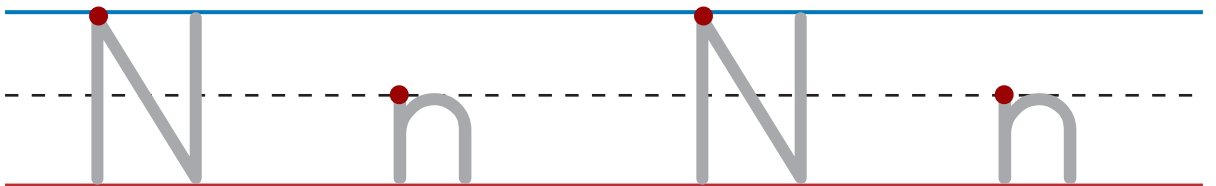
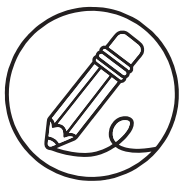
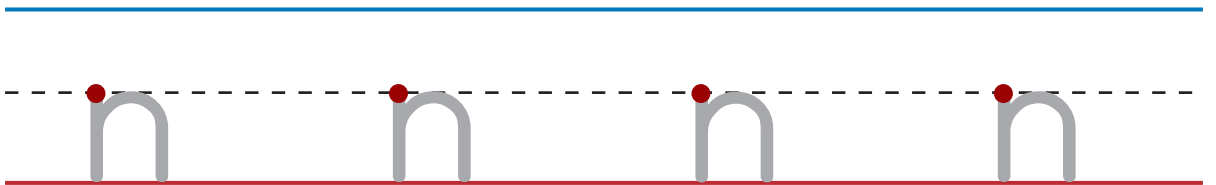
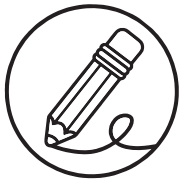
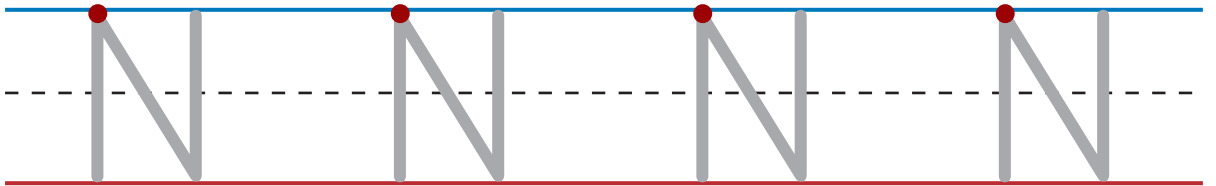
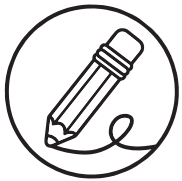
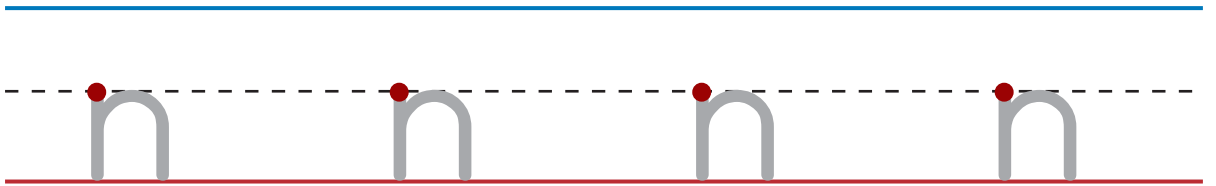
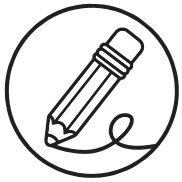
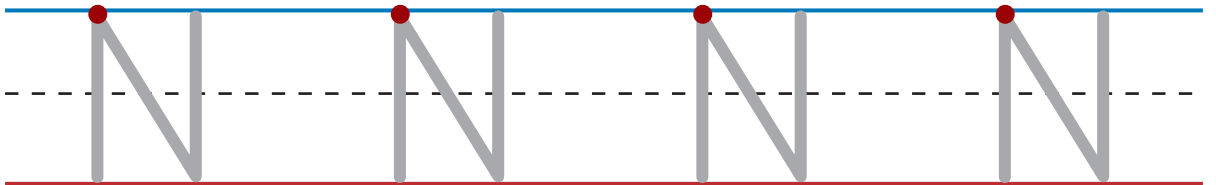
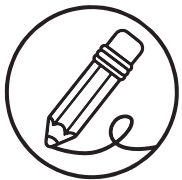

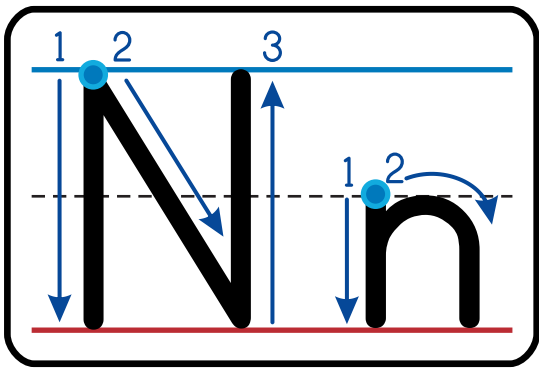

Name:

Letter Sort

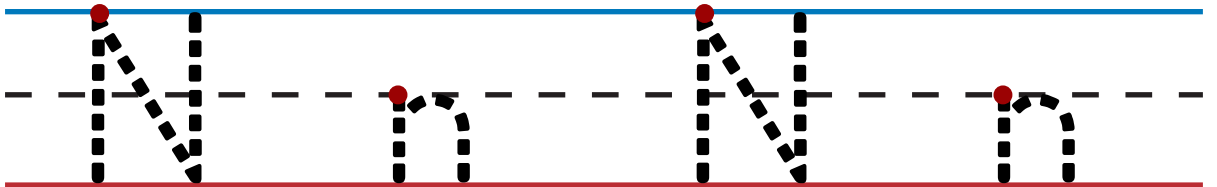
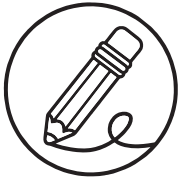

--	--	--	--

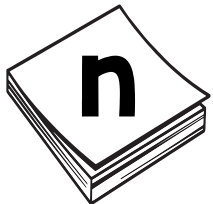

--	--	--	--

Letter of the Week by Lavinia Pop © 2013

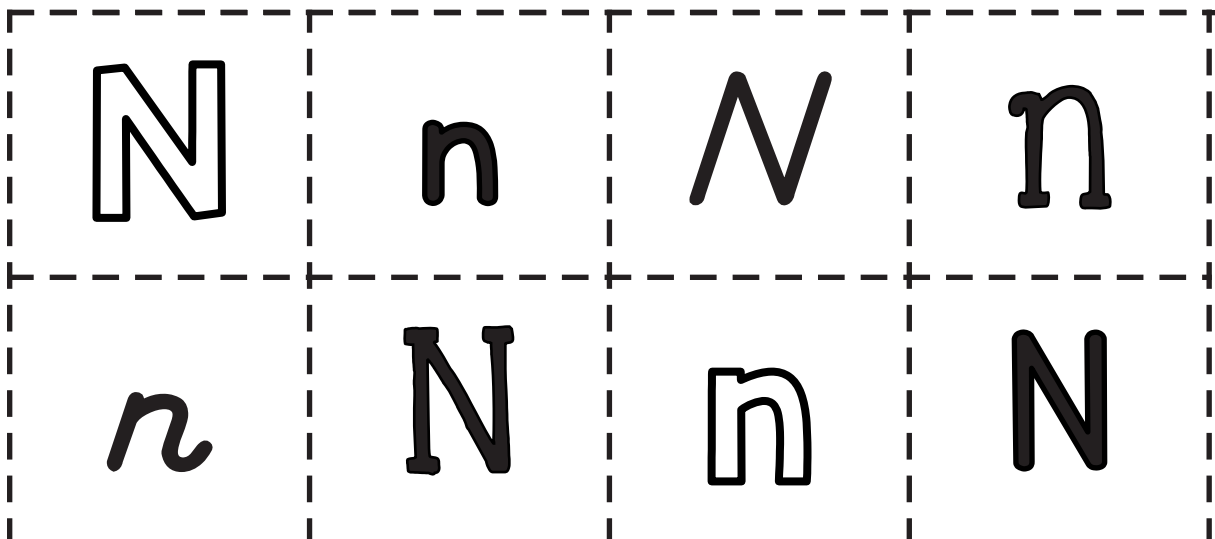
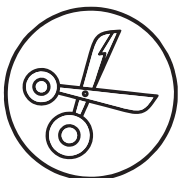

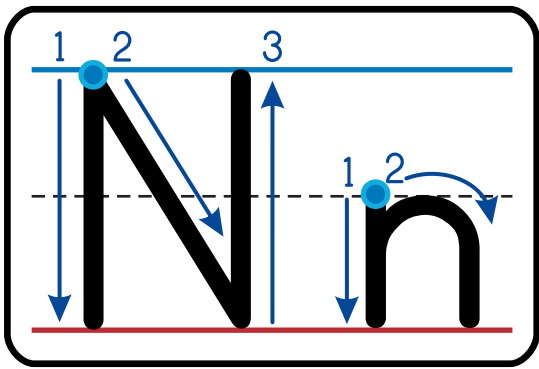

Name:

Letter Sort

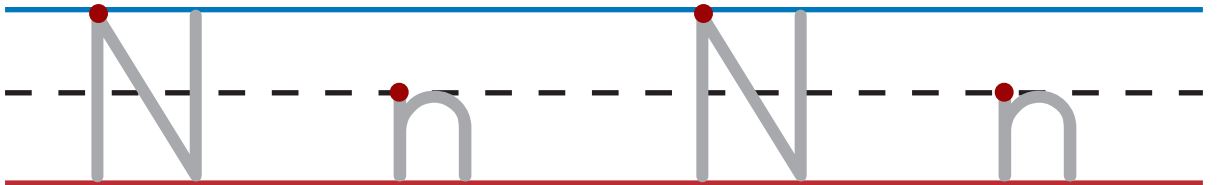
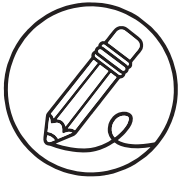

--	--	--	--

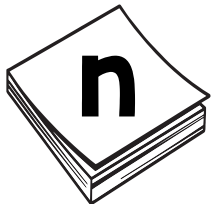

--	--	--	--

Letter of the Week by Lavinia Pop © 2013

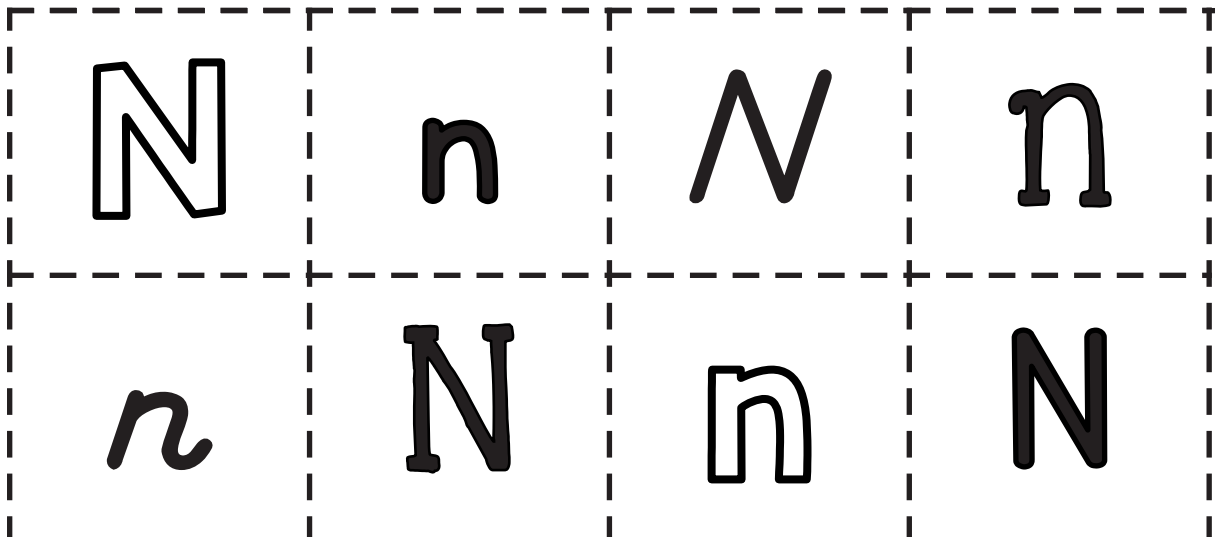
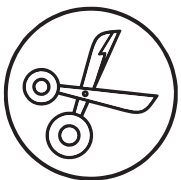

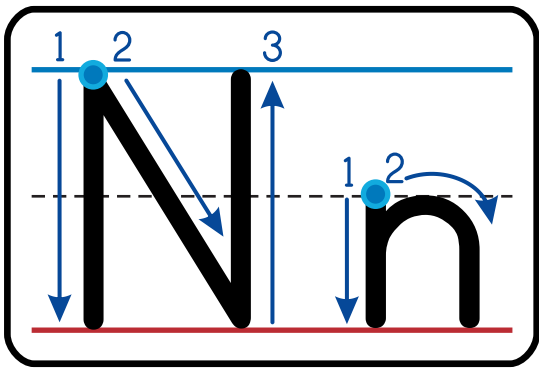

Name:

Beginning Sounds

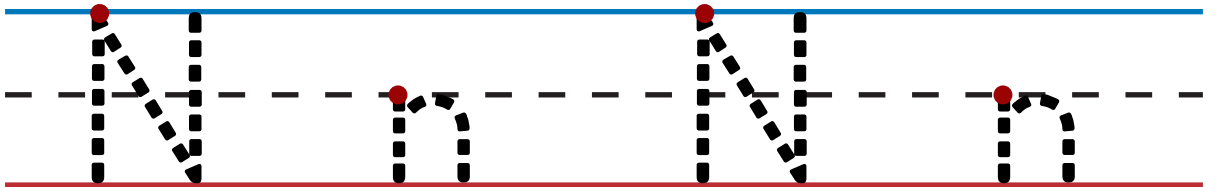
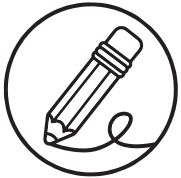

N

--	--	--	--

~~N~~

--	--	--	--

Letter of the Week by Lavinia Pop © 2013

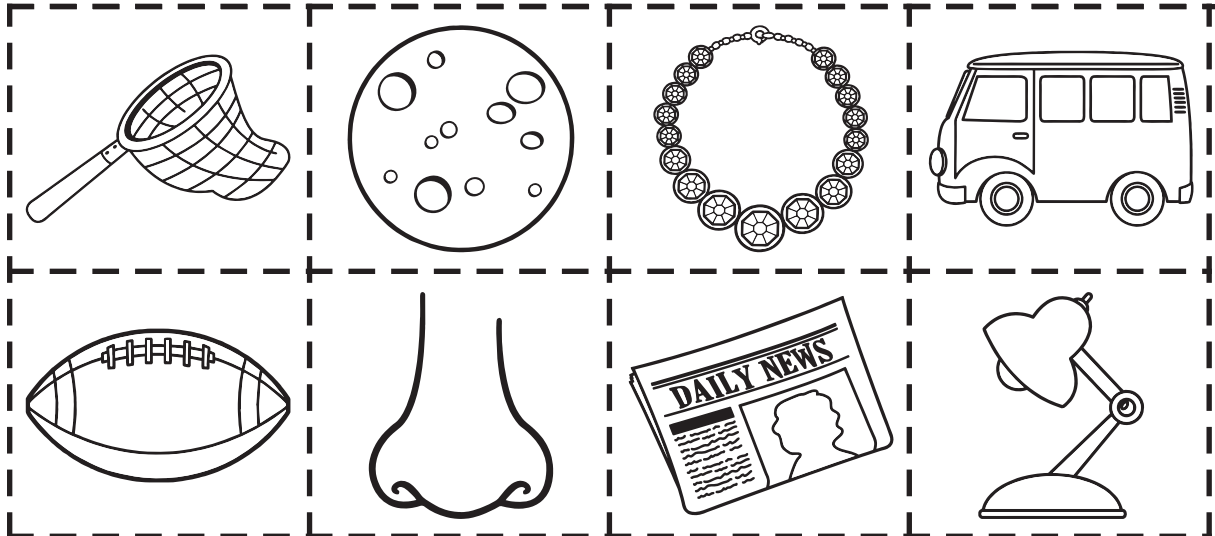
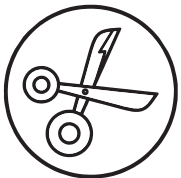

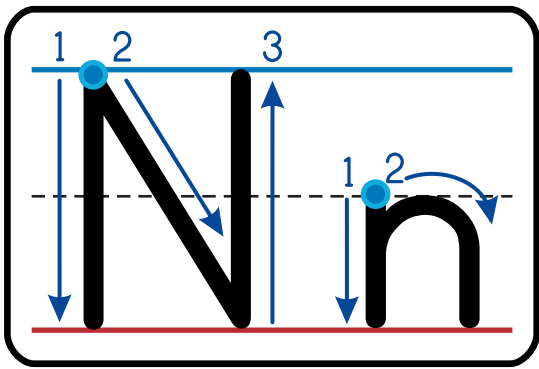

Name:

Beginning Sounds

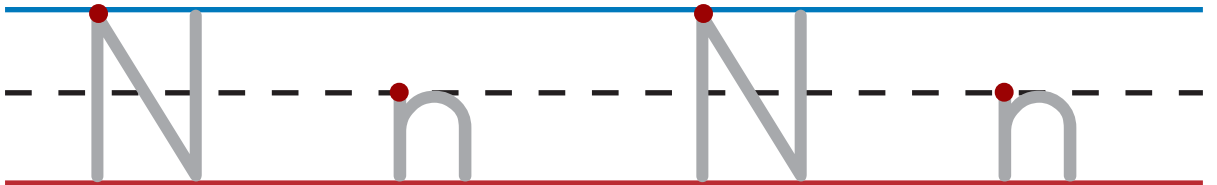
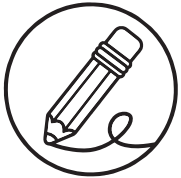

N

--	--	--	--

~~N~~

--	--	--	--

Letter of the Week by Lavinia Pop © 2013

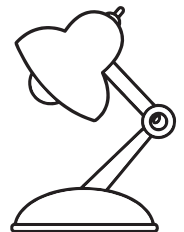
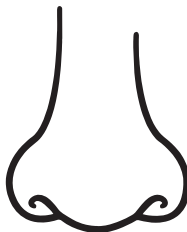
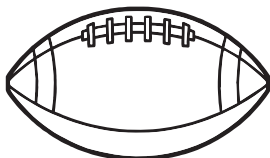
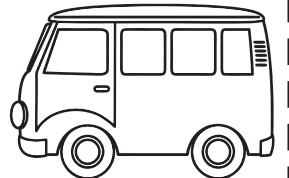
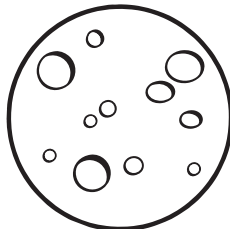
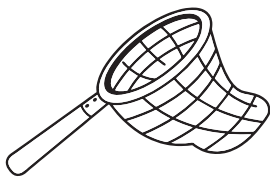
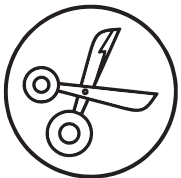

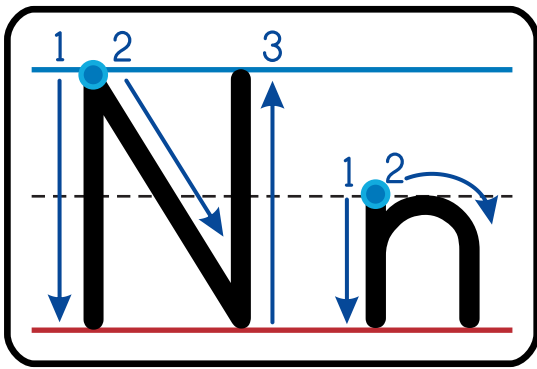

Name:

Word Match

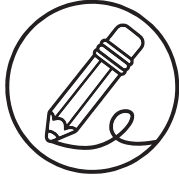

Trace



Glue

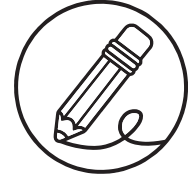

Write

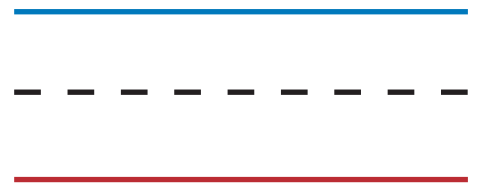
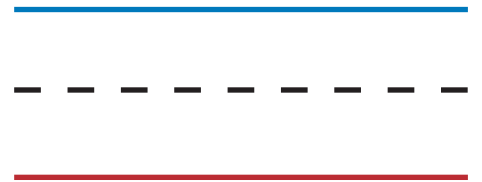
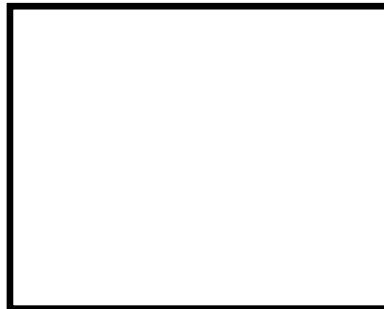
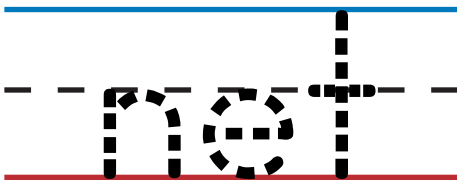
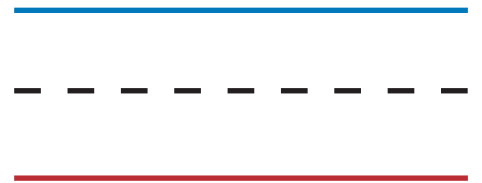
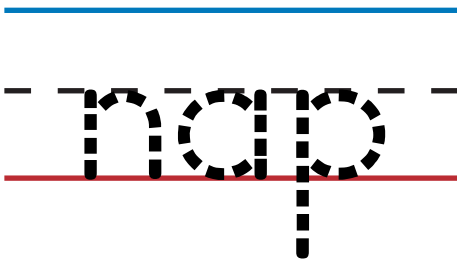

Letter of the Week by Lavinia Pop © 2013

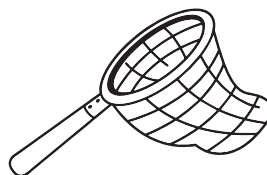
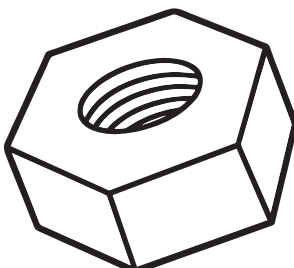
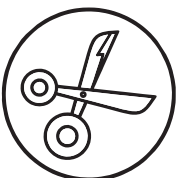

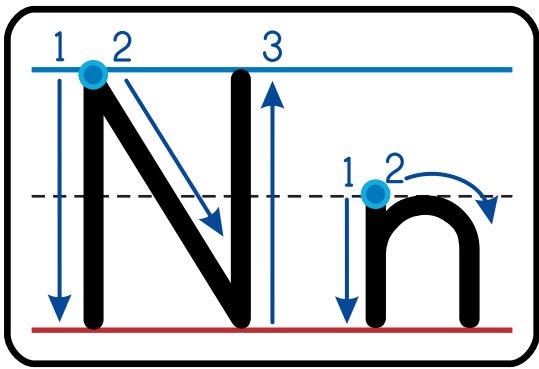

Name:

Word Match

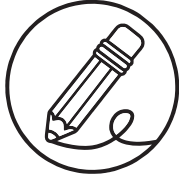

Trace



Glue

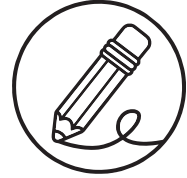

Write

nap



Blank handwriting lines for writing the word 'nap'.

net

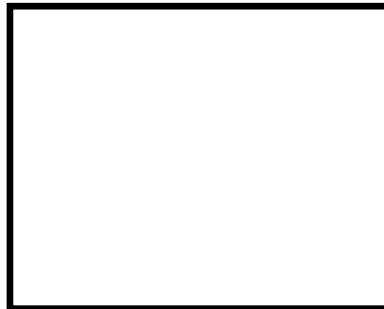

Blank handwriting lines for writing the word 'net'.

nut



Blank handwriting lines for writing the word 'nut'.

Letter of the Week by Lavinia Pop © 2013

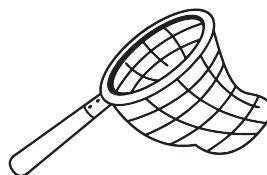
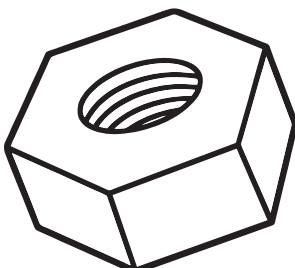
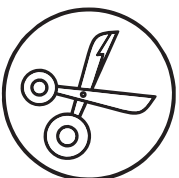

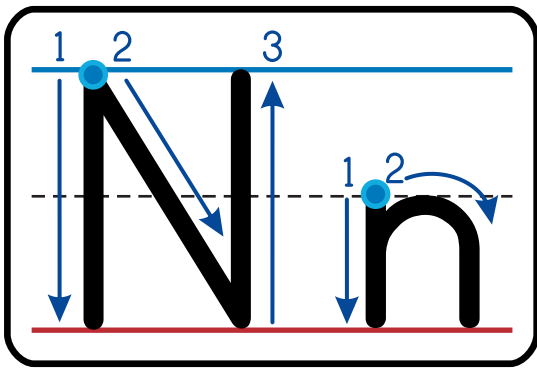

Name:

Read-Match-Write



Read the words below. Draw a line to match each word to the correct picture. Write the words in the matching boxes. Draw a line to match each picture to the correct box.

nip

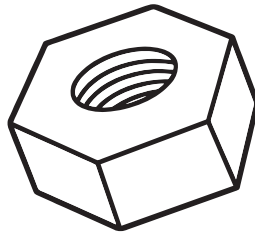

net



nit

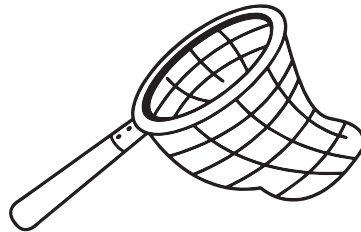

nut



nap

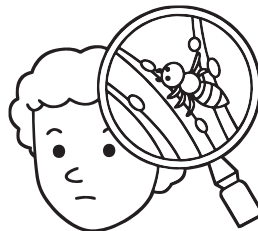

nod



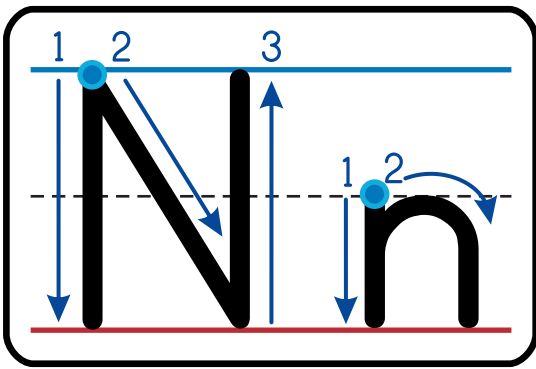

Name:

Homework

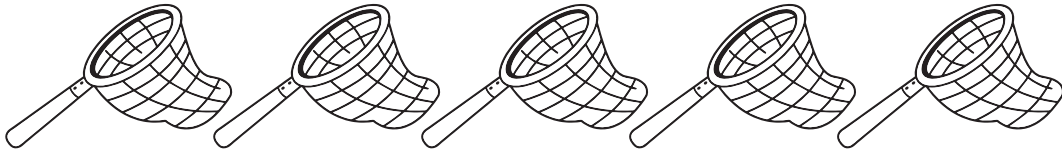

Color a net each time you do this page.

- 1 Say the names for the following pictures. Circle the pictures if you hear the “Nn” sound. Is the sound at the beginning, middle or ending of the word?

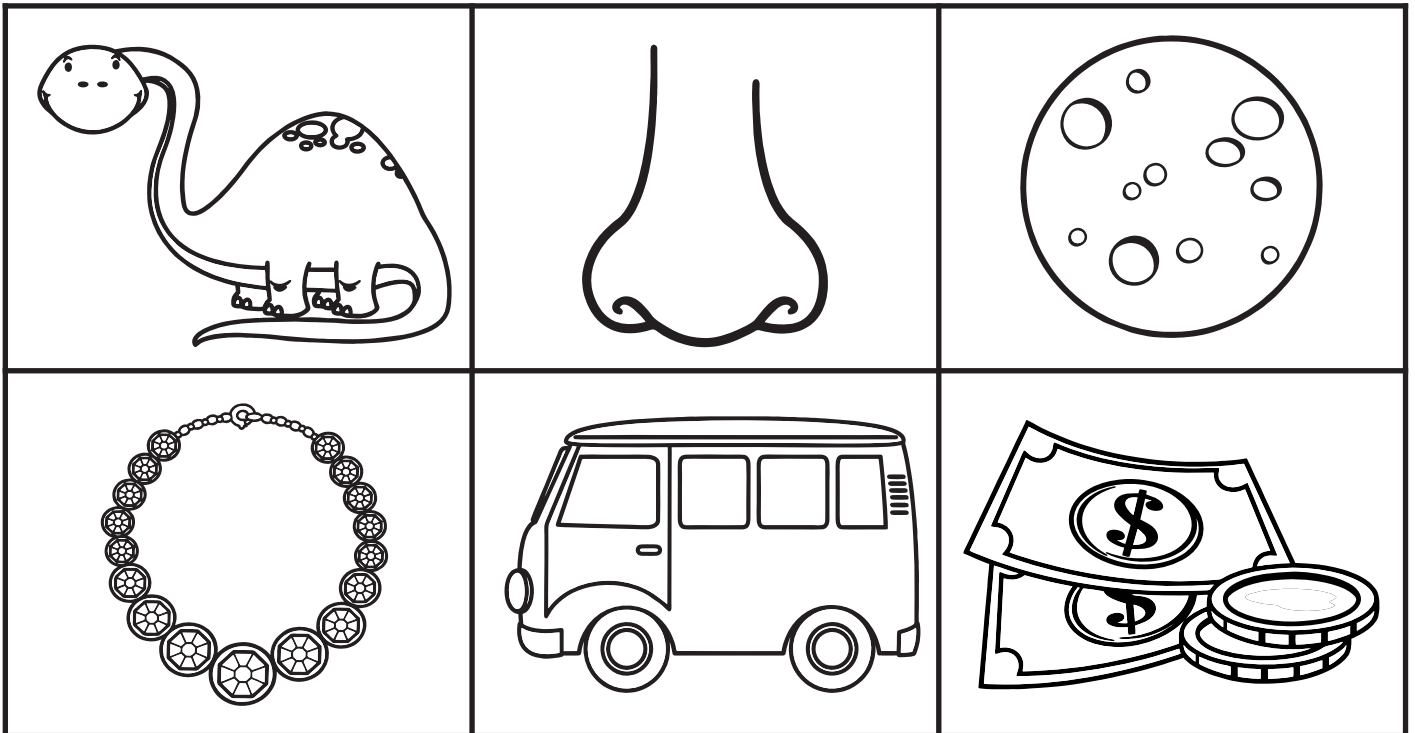

- 2 Think of other words that have the “Nn” sound.

- 3 Read the following words:

nag net nip nod nut

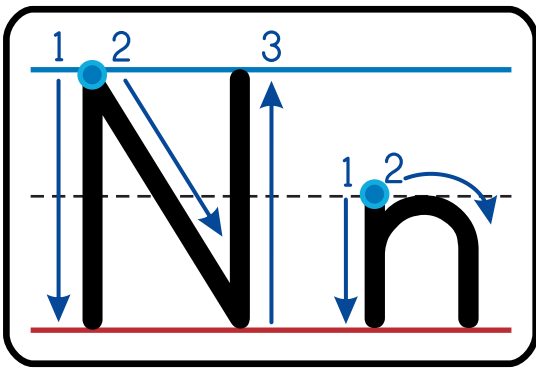

Name:

Reading Fluency

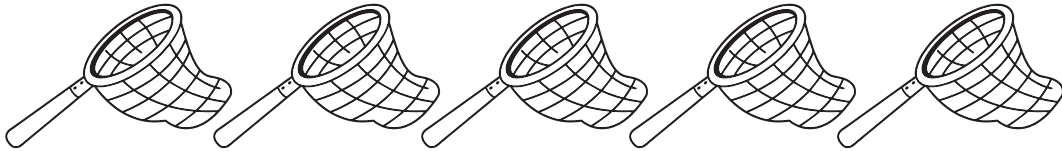

Color a net each time you read all the sentences.

N is for nap.



N is for net.

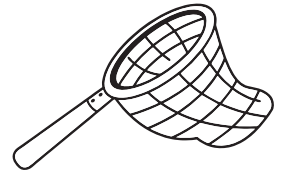

N is for nip.



N is for nit.



N is for nod.



N is for nut.

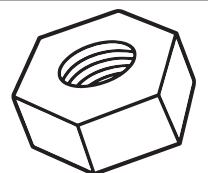

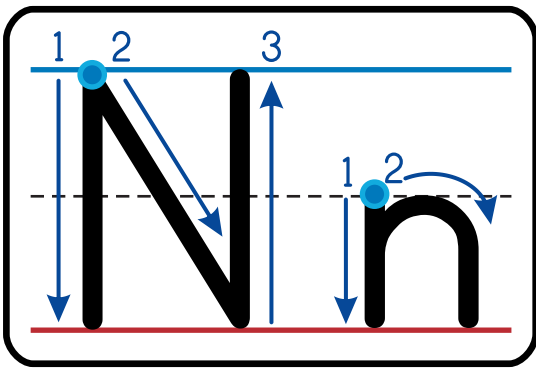

Name:

Reading



Read and trace the words. Underline n.

nine

nest

nose

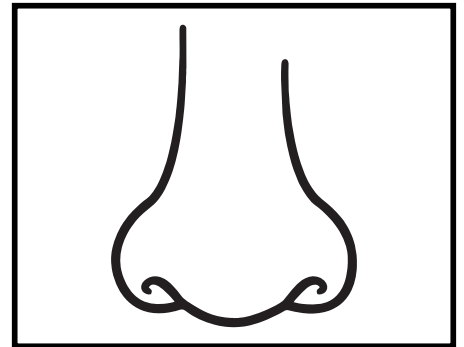
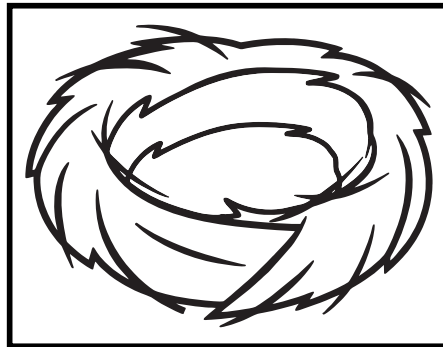
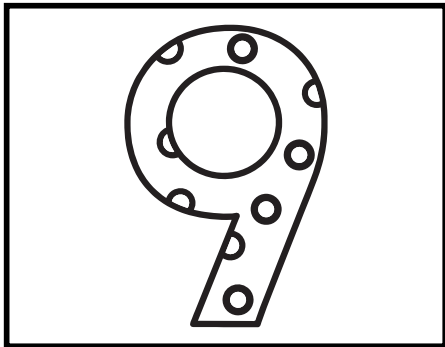

Underline N and n in the nursery rhyme.

**Now the day is over,
And night is drawing nigh.
Shadows of the evening,
Steal across the sky.**

How many "Nn"s did you find? _____

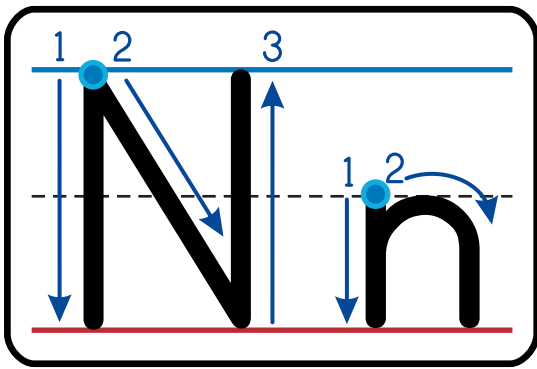

Name:

Build a Sentence



I will get a net.



--	--	--	--	--

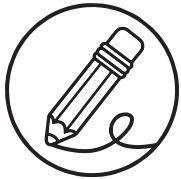

Blank handwriting lines for practice.

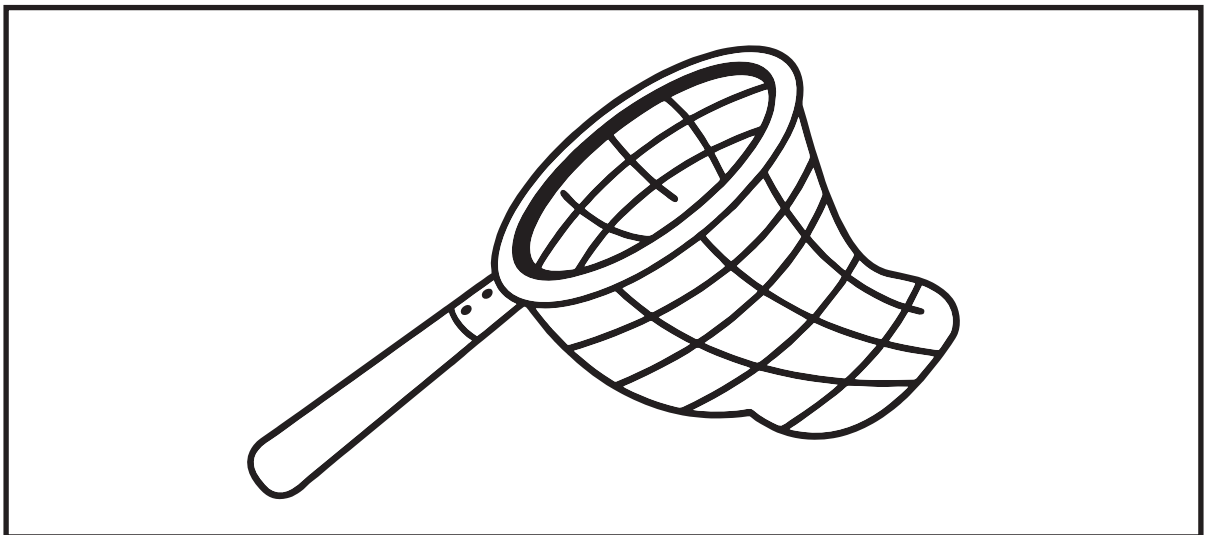
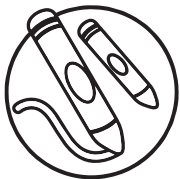

Letter of the Week by Lavinia Pop © 2013

will I net. a get

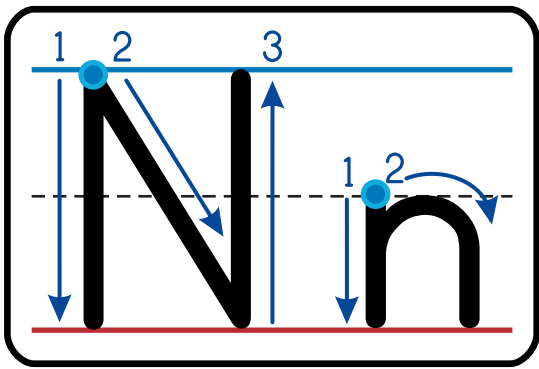

Name:

Build a Sentence



I will get a nut.



--	--	--	--	--

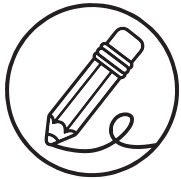

Blank handwriting lines for practice.

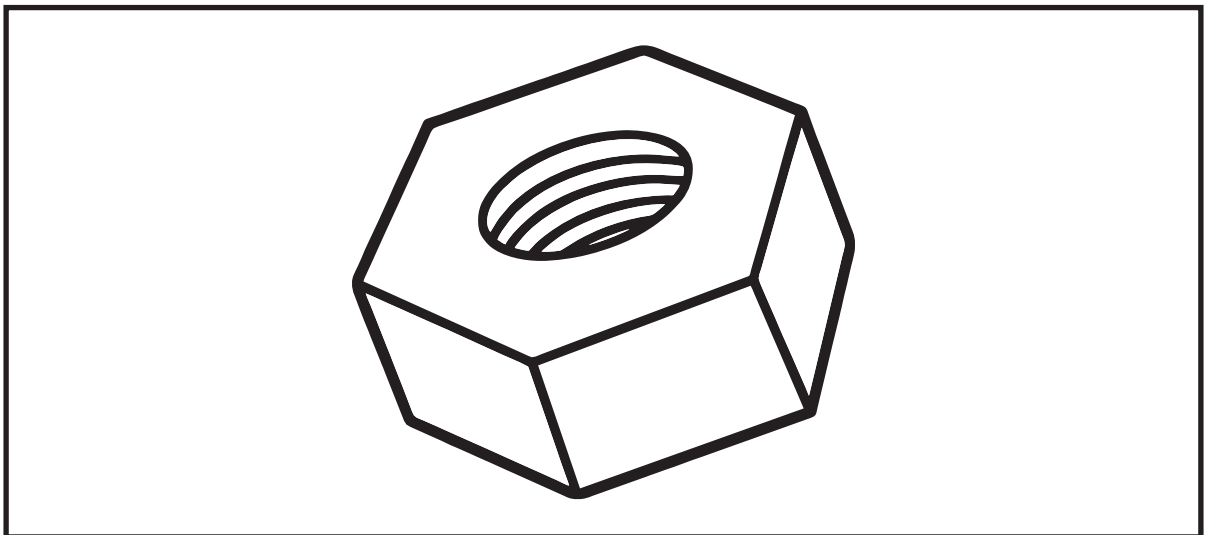
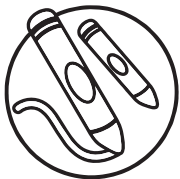

Letter of the Week by Lavinia Pop © 2013

nut. will I a get

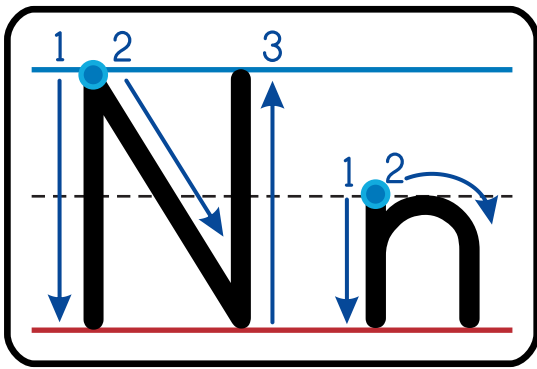

Name:

Build a Sentence



I will get a nest.



--	--	--	--	--

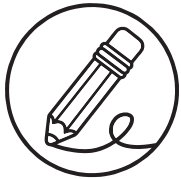

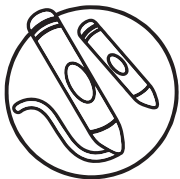

Letter of the Week by Lavinia Pop © 2013

a nest. will get I

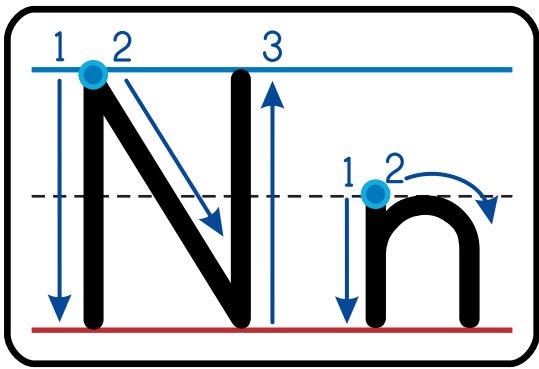

Name:

Build a Sentence



I will get a note.



--	--	--	--	--

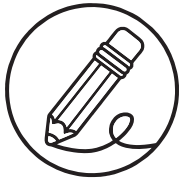

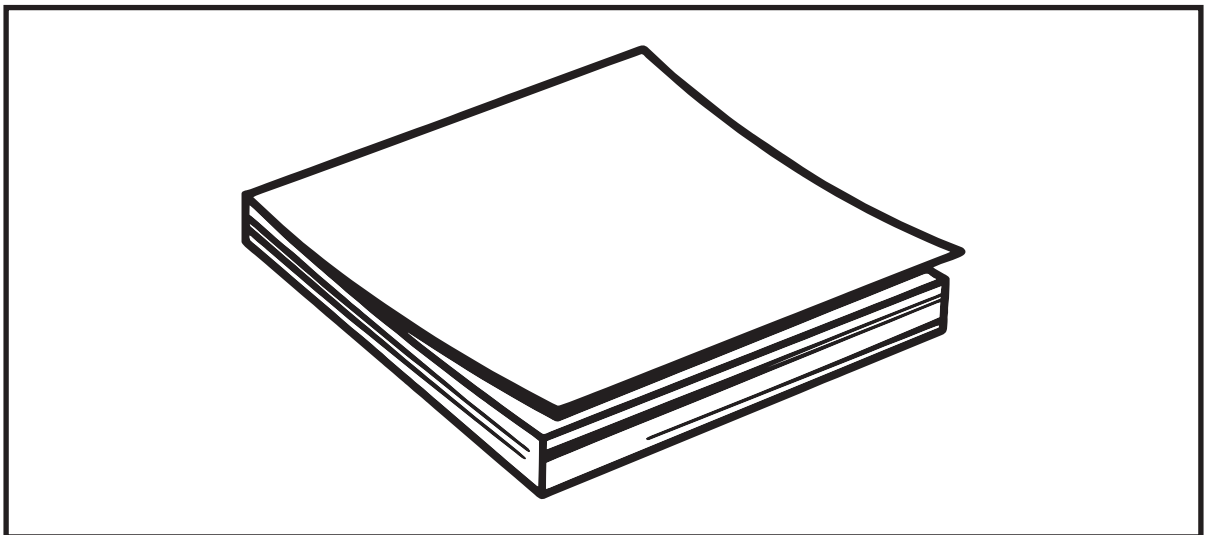
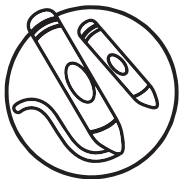

Letter of the Week by Lavinia Pop © 2013

will I note. a get

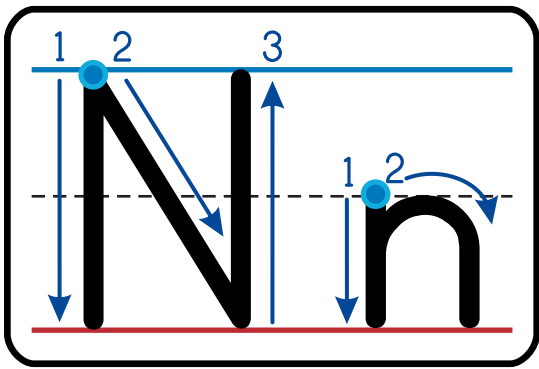

Name:

Build a Sentence



I will get a nail.



--	--	--	--	--

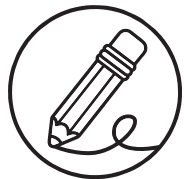

Blank handwriting lines for practice.

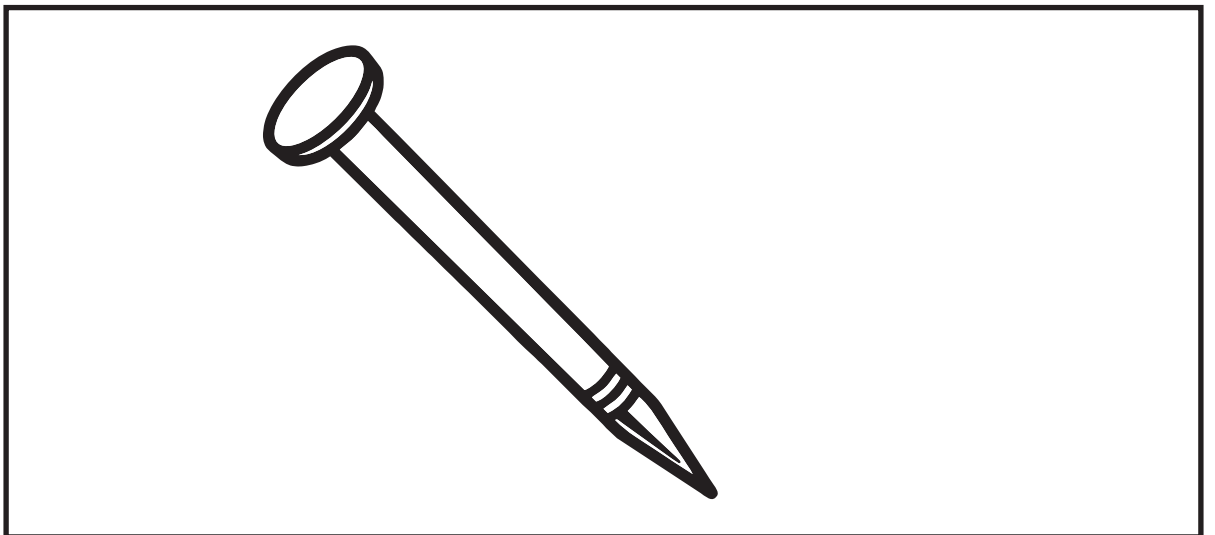
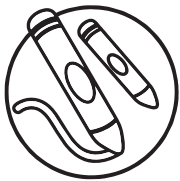

Letter of the Week by Lavinia Pop © 2013

nail. will I a get

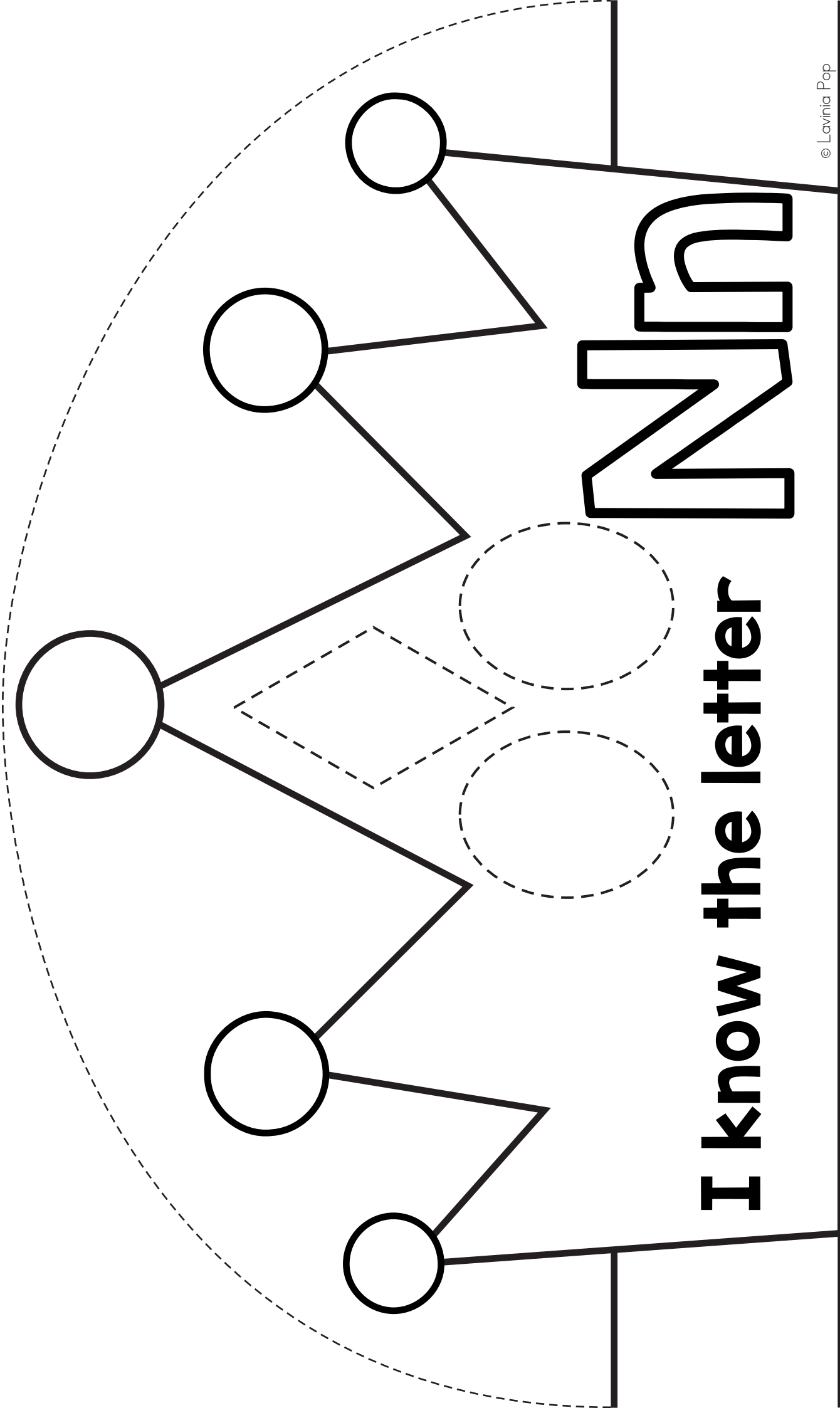

I know the letter

2020

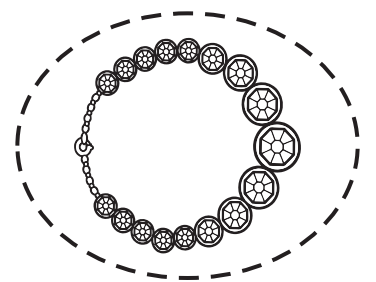
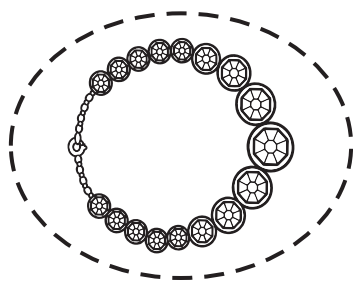
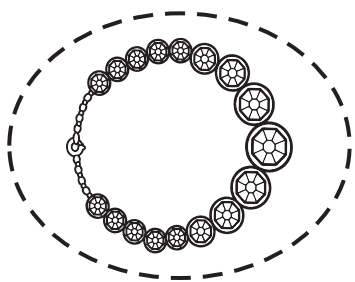
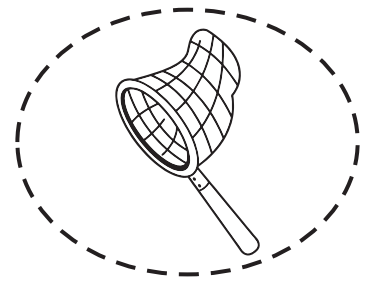
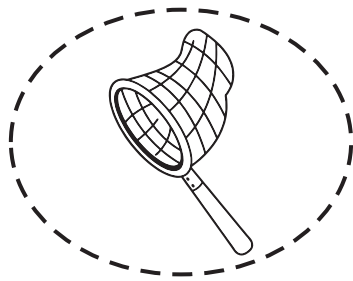
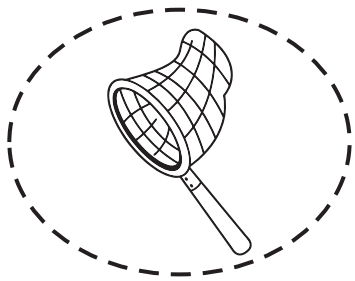
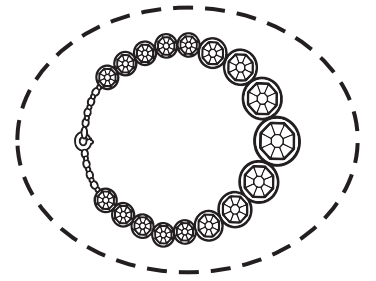
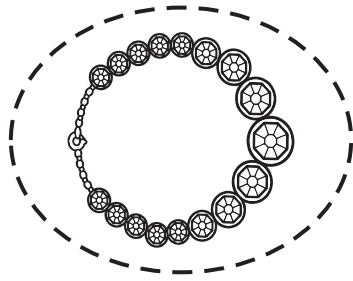
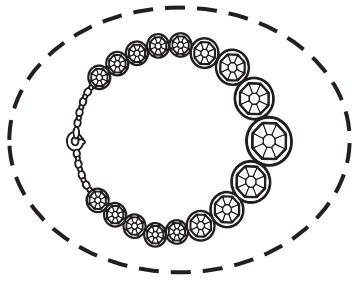
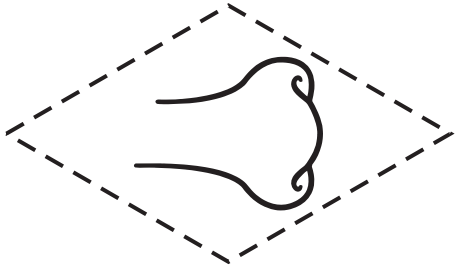
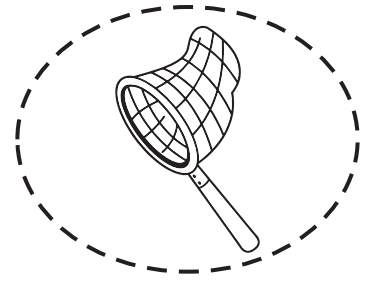
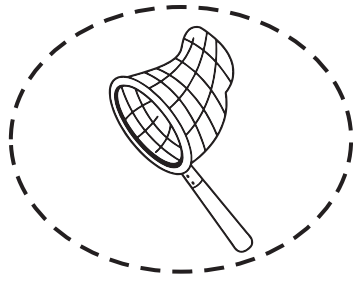
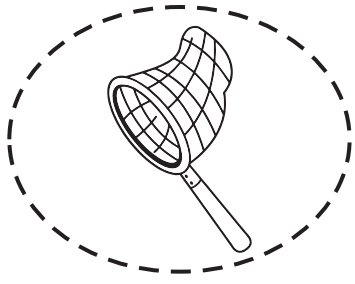

g|ue/stap|e

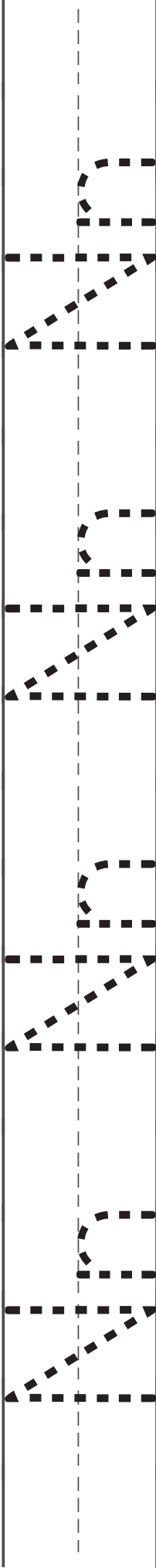

g|ue/stap|e

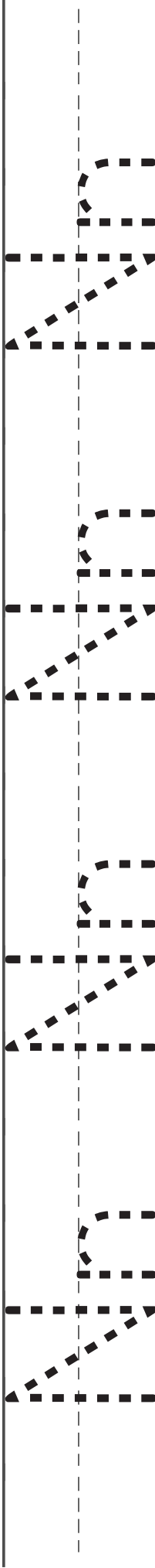

g|ue/stap|e

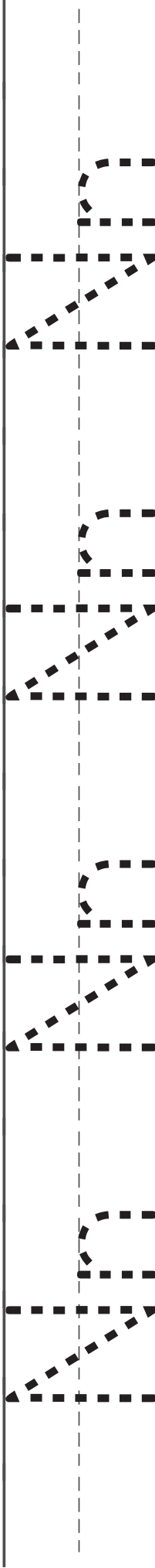

g|ue/stap|e

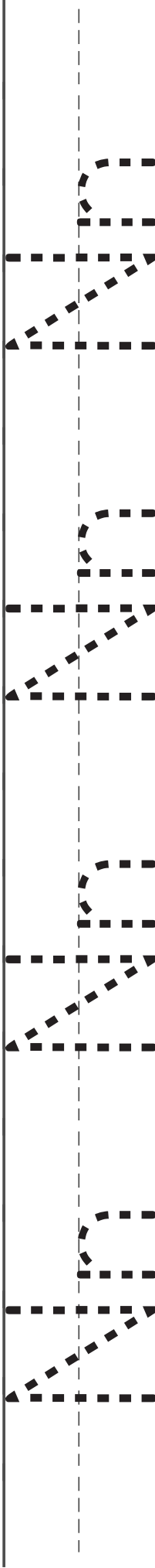

g|ue/stap|e

g|ue/stap|e

g|ue/stap|e

g|ue/stap|e

